

Changes for the Better

Mitsubishi iQ Platform
Programmable Controller
MELSEC-Q Series [QnU]



The next level in Q performance

New products are added to lineup!

[Low-capacity type]
Q00UJ/ Q00U/ Q01U

[Medium/High-capacity type]
Q10U/ Q20U

MELSEC **Q** series
QnU

Mitsubishi Electric Corporation Nagoya Works is a factory certified for ISO14001 (standards for environmental management systems) and ISO9001 (standards for quality assurance management systems)



Unprecedented level of performance...

The next generation Q Series has arrived!

"Universal model: QnU" is the next generation MELSEC-Q Series. It is an ideal solution for users who want to increase productivity and processing speed of large-volume production information, which is critical for traceability.

It is the fastest basic operation processing on the market* and can greatly improve performance of systems. Furthermore, the design concepts inherited from the Q Series make it more user-friendly and reliable.

This new generation programmable controller will bring your systems to the next level

[High speed, high capacity]

In order to support the complex product equipment, "Universal model: QnU" provides the fastest data processing operation available on the market. Furthermore, the machine control with the higher speed and higher accuracy can be performed by using the multiple CPU system. The number of programs and memory capacity that can be handled to process the large amount of control/production management data are increased.

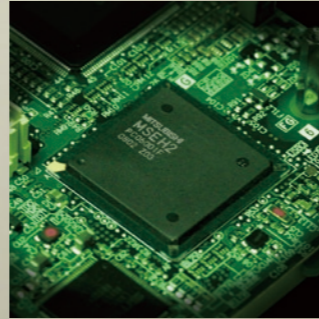

[Built-in Ethernet/USB port]

The Ethernet connection is standardized for the top layer of the information network. The Ethernet port is built in the main body of "Universal model: QnU". (Q03U and later) The USB port is standardized for all models to improve the usability.



[Enhanced lineup]

The low-capacity type models are added to the lineup of the new generation programmable controller, "Universal model: QnU". Program capacity of 10 k to 260 k can be selected for a specific purpose.

*As of October 2008



Current production requirements

- Minimizing operation cycle
- Corresponding to strict quality management
- Adopting more complex, larger-scale equipment
- Supporting increasingly large volume control/production management data
- Responding to short product life cycle
- Improving equipment uptime

Such needs at production site gave birth to this next generation programmable controller

Improved Productivity

More User - Friendly

Easy Maintenance



MELSEC **Q** series

QnU

Improved Productivity



High-speed, high-accuracy machine control

By simultaneously processing a sequence program and multiple CPU high-speed communication (operation cycle of 0.88 ms), high-speed control is achieved. The multiple CPU high-speed communication cycle is synchronized with motion control, cutting down unnecessary control. Moreover, performance of motion control is two times faster than the previous model, allowing high-speed, high-accuracy machine control.

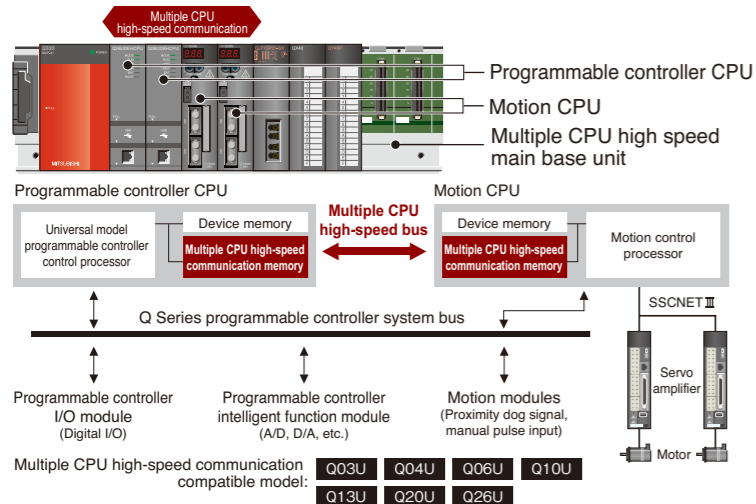

The indicated CPU icons of compatible model include the Ethernet port type and RS-232 port type.
Example) **Q03U** : Q03UDECPU, Q03UDCPU

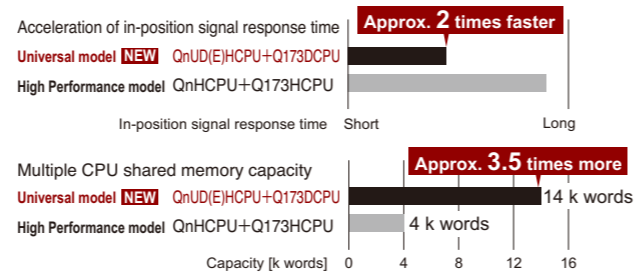
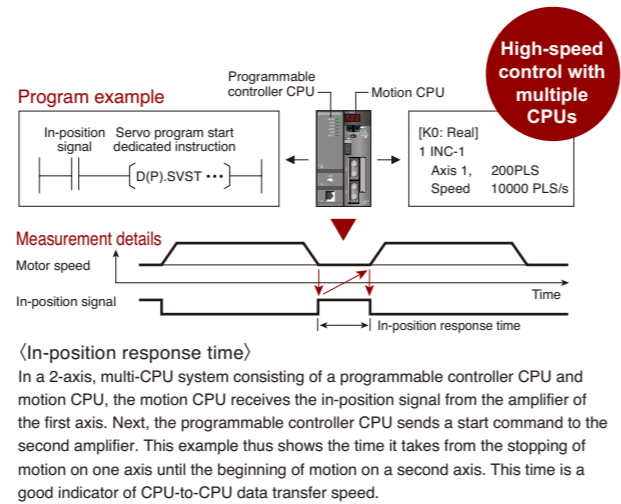

Improved production time with ultra-high-speed processing

To correspond with increasing demands for shortening production time of large-scale, complex systems, the new model offers the fastest basic operation performance* on the market: basic operation processing speed (LD) of 9.5 ns. This means scan time is reduced, improving production time and processing accuracy. In addition, the programmable controller can realize high-speed control which was previously supported by micro computer boards only.

*As of October 2008

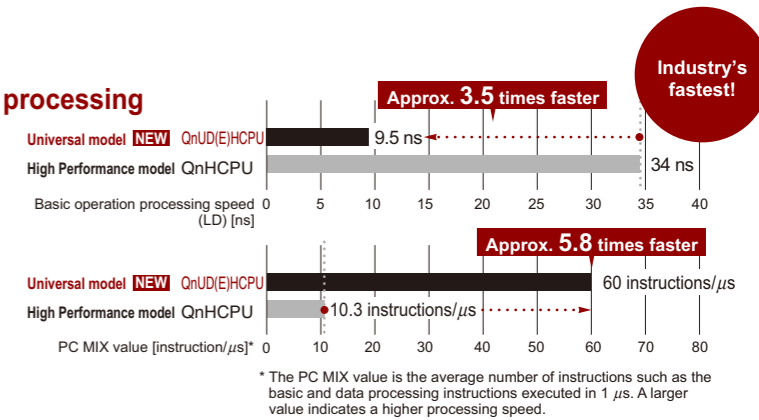

High-speed, high-precision real data processing

Floating point addition instruction processing speed is greatly increased to 0.057 μs to support high-speed, high-precision operation processing of various production data. Also, double precision operation is added to reduce calculation errors when implementing complex equations.

Universal model (New model)	QnUD(E)HCPU: Q04/ 06/ 10/ 13/ 20/ 26UDEHCPU
High Performance model	QnHCPU : Q02/ 06/ 12/ 25HCPU

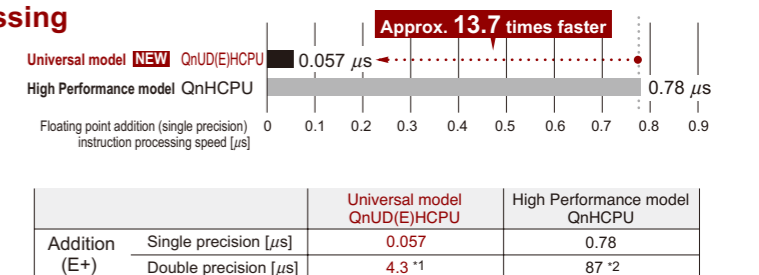

	Universal model QnUD(E)HCPU	High Performance model QnHCPU
Addition (E+)	0.057	0.78
	4.3 *1	87 *2

*1 Minimum value
*2 Indicates internal double precision operation processing speed

Expanded possibility by networking...

Built-in Ethernet Port CPU Modules

Q03UDE/ Q04U/ Q06U/ Q10U/ Q13U/ Q20U/ Q26UDEHCPU



7 modules added to line up!

Easy to connect to programming tool via Ethernet

IP address setting is not required to connect GX Developer (programming tool) to the CPU module directly (one-to-one connection). Also, the CPU module allows the use of either straight or cross cable. Ethernet thus realizes easy communication with the CPU module like USB connection, even operators who are not familiar with the network can easily connect it. (Patent pending)

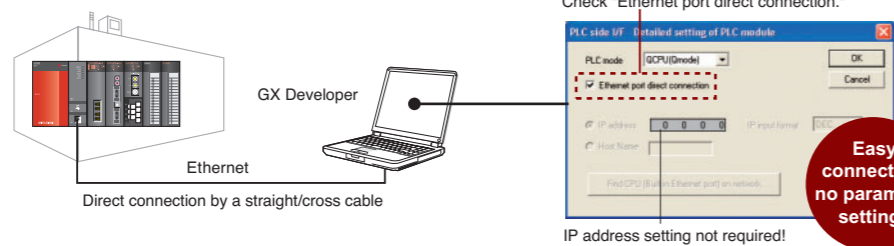

Easy connection, no parameter settings

Search and display a list of connected CPUs

Using an Ethernet hub, GX Developer can be simultaneously connected to multiple CPUs. The connected CPUs on the network can be searched and displayed in a list. By selecting a CPU from the list, it is connected easily even if the IP address is unknown, and the operating status can be checked.

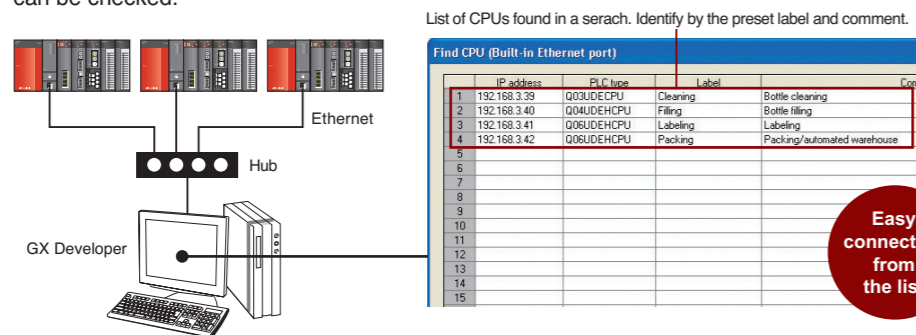

Easy connection from the list

Connect to various devices according to applications

High-speed communication with external devices is available via Ethernet. According to application requirements, various devices can be connected.

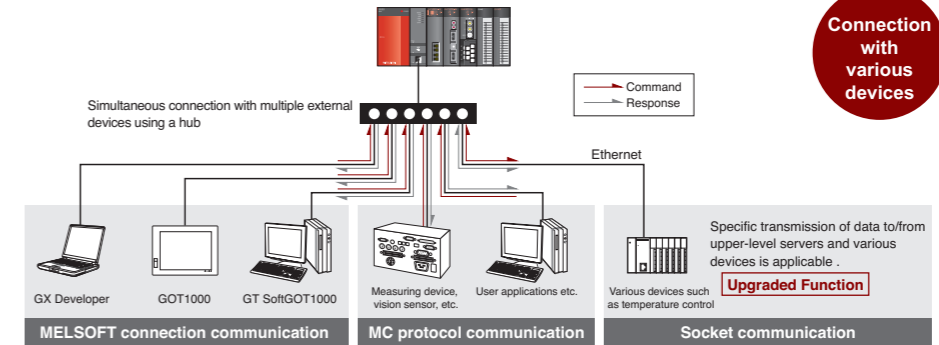

Connection with various devices

Seamless communication across all layers

The QnU model supports the high-speed, high-capacity CC-Link IE Controller Network to allow for massive data exchange. It can also communicate with MELSECNET/H, Ethernet, and CC-Link seamlessly beyond the network type and hierarchy. Each programmable controller on the network can be monitored/programmed by GX Developer connected via Ethernet.

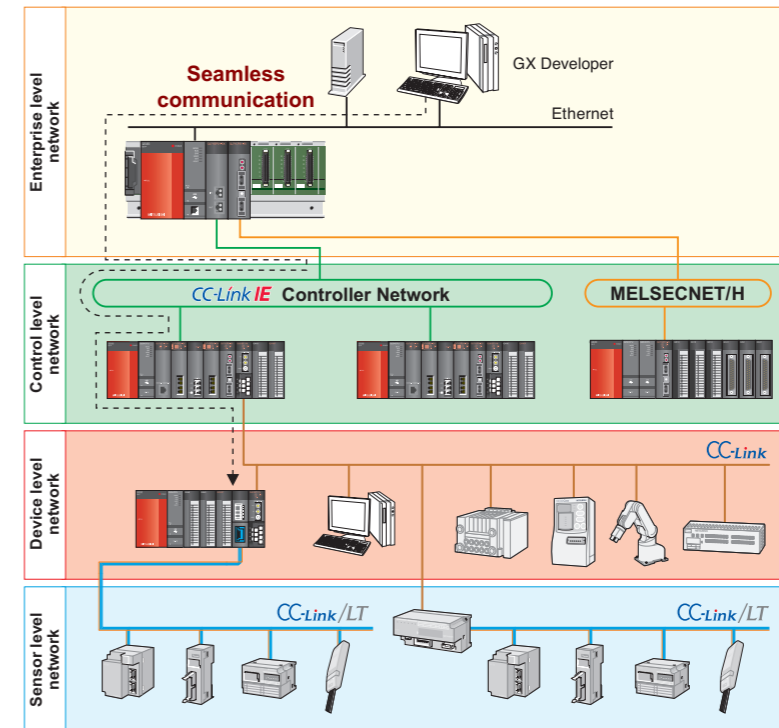

Access beyond hierarchy

Always provide accurate clock data

With the SNTP* clock synchronization function, clock synchronization, which is a bottleneck factor, is automatically performed. Accurate time of error occurrence can be grasped, enabling the user to easily confirm the multiple CPU related error occurrence timing.

* SNTP: Simple Network Time Protocol

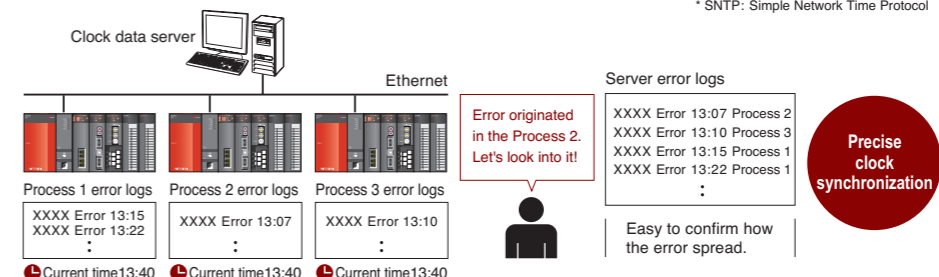

Precise clock synchronization

Wide variety of products for your needs

Enhanced lineup from low capacity to high capacity

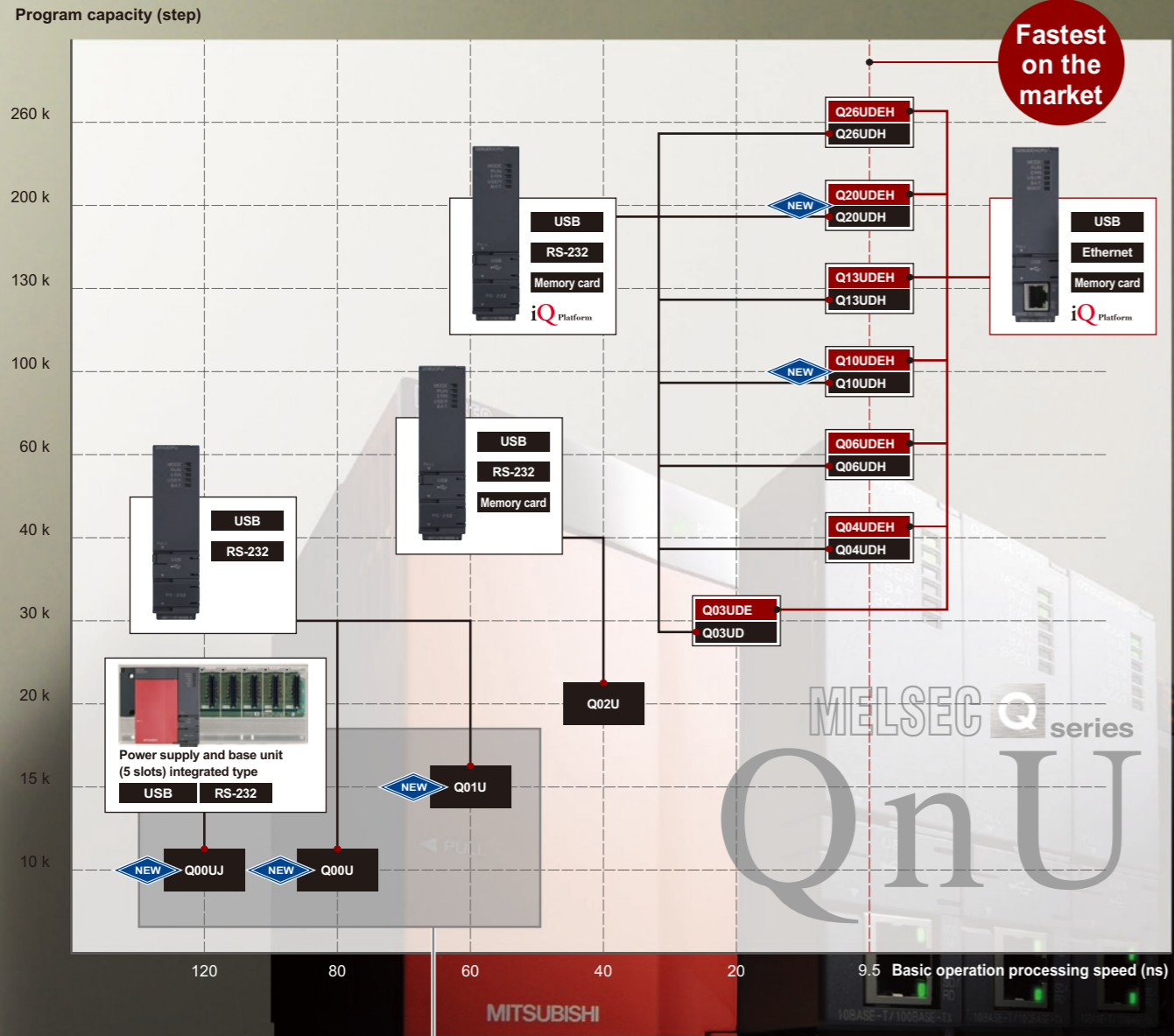

Enhanced lineup

7 new models are added to the 11 existing models. Wide variety of modules are available to suit your needs of performance and functions.

- The USB port is standardized for all models and either Ethernet port type or RS-232 port type can be selected.

Compatible model: Q03U Q04U Q06U Q10U Q13U Q20U Q26U

- CPU's from low capacity to high capacity can be selected according to your program size.

Enhanced lineup

Easy programming with the convenient instructions **Upgraded Function**

The convenient instructions such as the scaling instruction, exponentiation instruction, and rising/falling pulse contact instruction of closed contact are added. Programming that used to require complicated processes is now improved efficiently and thus the programming work is reduced.

Reduced programming work

[Scaling instruction]

The result of scaling for the conversion data (Point 1 to n in the figure below) with the specified input value is stored to the specified device number as the output value.

◎ Configuration of conversion data for scaling

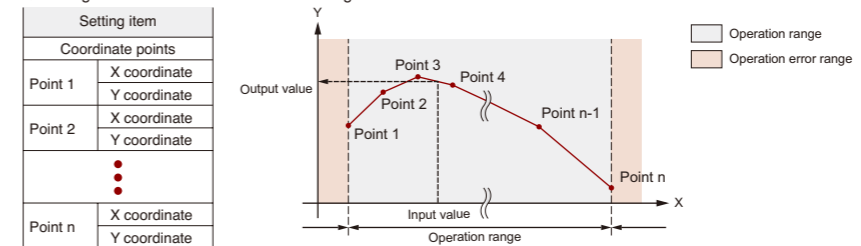

[Exponentiation instruction]

The exponentiation operation can be performed with the specified floating-point real number.

Example) Exponentiation operation on 32-bit floating-point real numbers D0, D1 and D10, D11

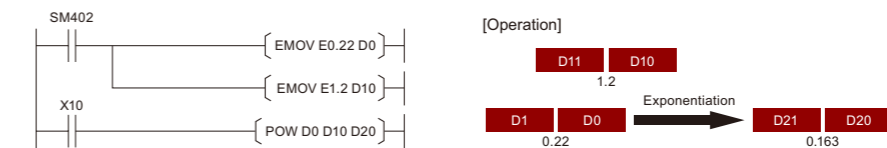

[Rising/falling pulse contact instruction of closed contact]

Previously, multiple instructions are required for the rising/falling conditions of closed contact, but now, the rising/falling pulse contact instruction of closed contact is available for the efficient programming.

◎ Time chart

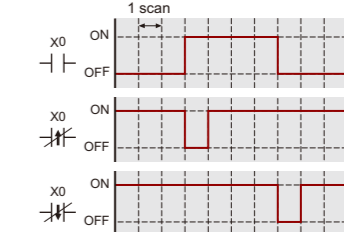

◎ Added instructions

Category	Instruction	Symbol
Contact instruction	Pulse operation start of closed contact	LDPI, LDFI
	Pulse series connection of closed contact	ANDPI, ANDFI
	Pulse parallel connection of closed contact	ORPI, ORFI
Shift instruction	n-bit right/left shift of n-bit data	SFTBR, SFTBL
Data processing instruction	Average value calculation	MEAN, DMEAN
	String processing instruction	String insertion
Special function instruction	String deletion	STRDEL
	Floating-point exponentiation operation	POW, POWD
Data control instruction	Floating-point common logarithm operation	LOG10, LOG10D
	Scaling (coordinate by point data)	SCL, DSCL
Clock instruction	Scaling (coordinate by X/Y data)	SCL2, DSCL2
	Date comparison	DT=, DT<>, DT>, DT<=, DT<, DT>=
	Time comparison	TM=, TM<>, TM>, TM<=, TM<, TM>=

Compatible model: Q00UJ Q00U Q01U Q02U Q03U Q04U Q06U Q10U Q13U Q20U Q26U

Improved performance

Compared to Basic model QCPU, the performance is improved efficiently.

Compatible with multiple programs

Compatible with up to 32 programs. With the use of common instructions, programs can be used for all Universal model modules. Thus the program assets are easily utilized when changing the CPU types.

Standardized USB port

Even when the RS-232 port is occupied by a peripheral such as a display device, the programming tool can be connected to the USB port.



Low-capacity type is available

NEW

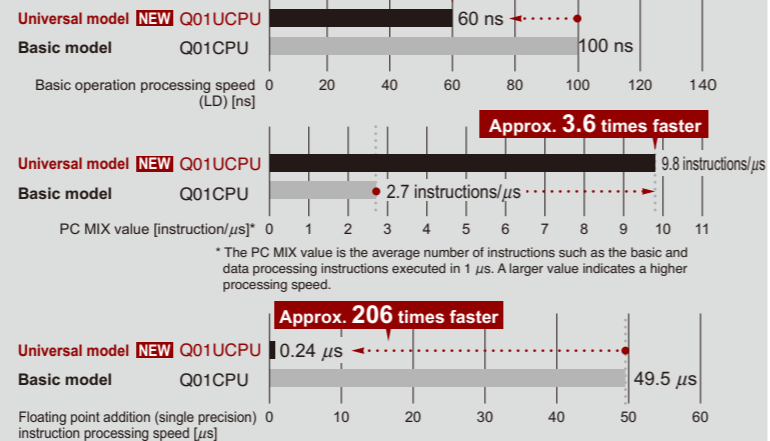

More User - Friendly

Programs structured into individual routines

The number of programs is increased to 124 (max.) to allow detailed program management by product, process, etc. This facilitates structuring programs into individual routines. Such structured programs can be highly utilized and enhance visibility. Also, standard ROM capacity is expanded to 4 MB (max.), enabling storage of label information of function block (FB) and device comments of sequence programs in CPU.

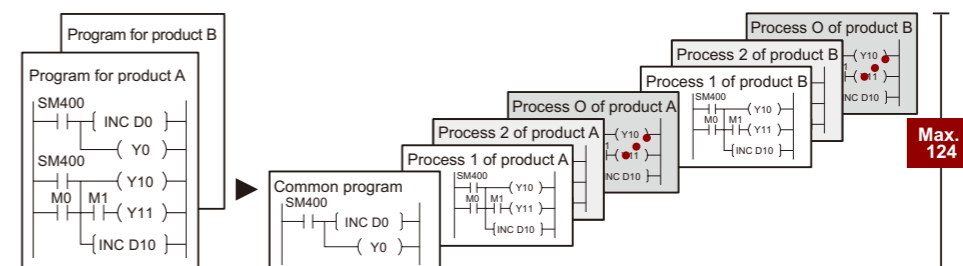

CPU	Q00UJ	Q00U	Q01U	Q02U	Q03UDE	Q04UDEH	Q06UDEH	Q10UDEH	Q13UDEH	Q20UDEH	Q26UDEH
	NEW	NEW	NEW				NEW	NEW	NEW	NEW	
Program capacity	10 k steps	15 k steps	20 k steps	30 k steps	40 k steps	60 k steps	100 k steps	130 k steps	200 k steps	260 k steps	
Program memory	32			64	124						
Standard ROM capacity (Flash ROM)	256 KB	512 KB			1 MB			2 MB		4 MB	

Easy to handle large-volume data

The capacity of standard RAM and memory card, which can be used as file register, is increased to store larger amounts of production and quality data. With an 8 MB SRAM, a maximum of 4086 k words (about 4 times more than the previous model) can be used for file registers. Furthermore, because the index register is extended to 32 bits, programming beyond 32 k words is possible, enabling use of the entire area of file register for indexing. (Except Q00UJCPU) To perform operation of structured (sequence) data efficiently, programming by indexing is necessary. Index register processing speed is also dramatically improved, which can shorten scan time when indexing is heavily used for sequence programs such as FOR to NEXT instruction.

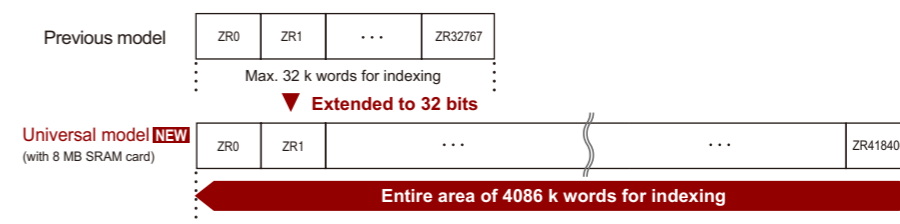
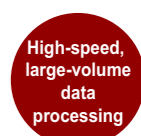

© Standard RAM capacity (file register capacity)

Q00UJ	Q00U	Q01U	Q02U	Q03UDE	Q04UDEH	Q06UDEH	Q10UDEH	Q13UDEH	Q20UDEH	Q26UDEH
NEW	NEW	NEW					NEW	NEW	NEW	
—	128 KB (64 k words)			192 KB (96 k words)	256 KB (128 k words)	768 KB (384 k words)	1024 KB (512 k words)		1280 KB (640 k words)	

© Memory card (SRAM)

Model	Q2MEM-1MBS	Q2MEM-2MBS	Q3MEM-4MBS	Q3MEM-8MBS
Capacity	1 MB	2 MB	4 MB	8 MB
File register capacity*	505 k words	1017 k words	2039 k words	4086 k words

* Maximum capacity when the memory card is used as file register. Memory card cannot be used for Q00UJ, Q00U, and Q01UCPU.

■ Shortened startup time with sampling trace function

The sampling trace function facilitates error analysis and program debugging timing verification, reducing equipment error analysis time and startup time. For a multiple CPU system, CPU-to-CPU data exchange timing can be also confirmed. The collected data can be not only viewed on GX Developer but also exported to a CSV file, allowing data analysis utilizing Excel.

Intuitive setting in Wizard format

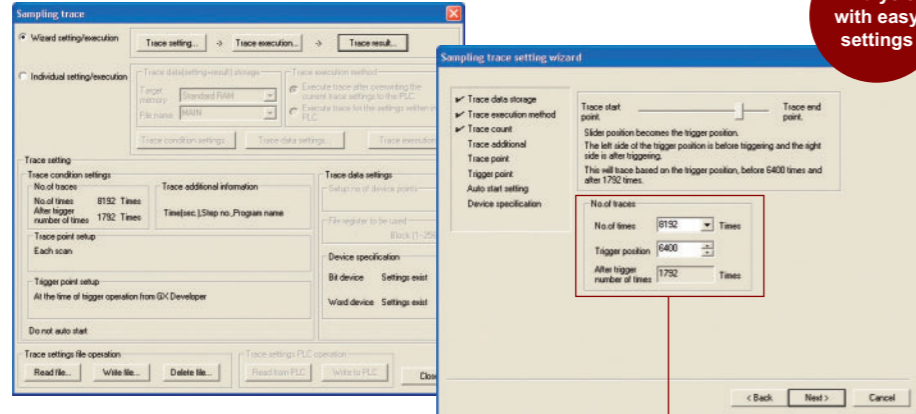

Analysis with easy settings

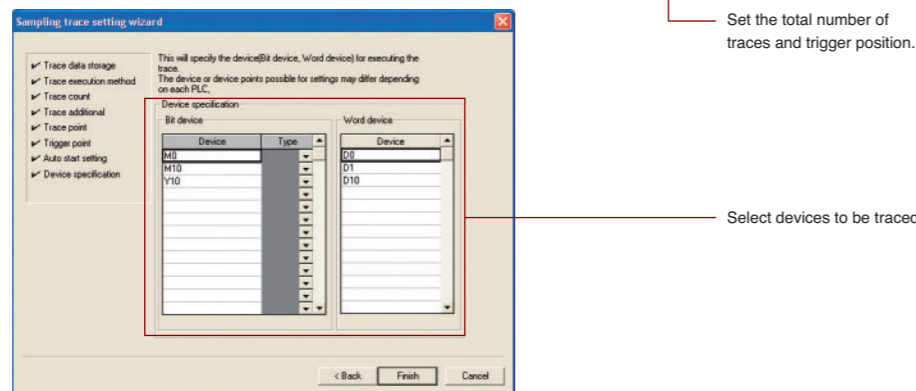

Set the total number of traces and trigger position.

Select devices to be traced.

Trace result

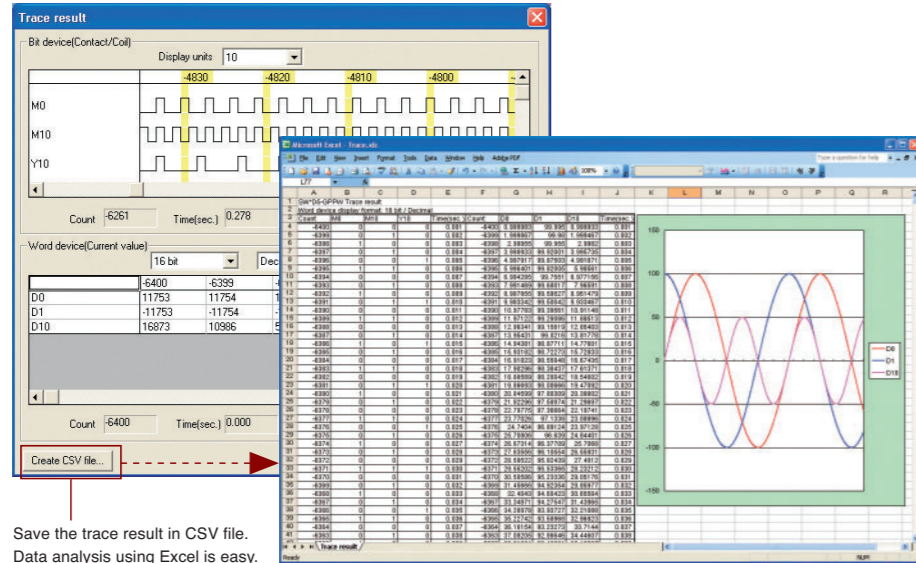

Compatible model: Q00U Q01U Q02U Q03U Q04U Q06U Q10U Q13U Q20U Q26U

■ Simplified program debugging task **Upgraded Function**

The QnU model features the "Executorial conditioned device test" function, which allows the user to change the device value to the specified value at any step in the program. Previously, a program for device setting must be added to debug a specific ladder block. However, using this function, only the specified ladder block can be debugged without modifying the program. This eliminates the program modification time for debugging and simplifies the debugging task.

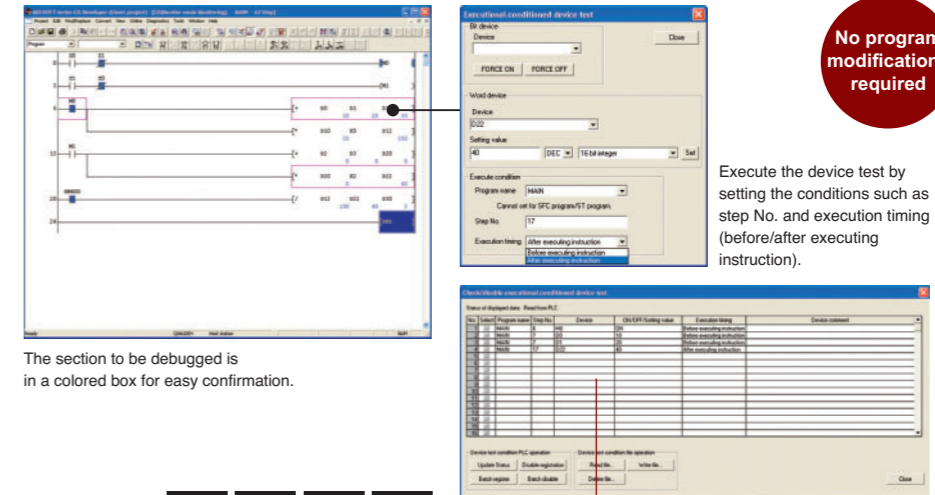

Compatible model: Q00U Q00U Q01U Q02U Q03U Q04U Q06U Q10U Q13U Q20U Q26U

No program modifications required

Execute the device test by setting the conditions such as step No. and execution timing (before/after executing instruction).

All sections to be tested are displayed in a list. Reading the registered conditions from the CPU and saving/reading the execution condition file are available.

■ Improved program creation with device extension **Upgraded Function**

[Bit device extension] The bit devices M and B can be extended up to 60 k points, improving program readability. (Previously up to 32 k points)

Compatible model: Q00U Q01U Q02U Q03U Q04U Q06U Q10U Q13U Q20U Q26U

Extended bit/word devices

[Extended data registers/extended link registers]

The device range is extended by using the standard ROM or memory card as D device or W device. (Previously used as file register (R/ZR)) Devices can be extended easily and flexibly for such case as word device increase by the program change.

Compatible model: Q00U Q01U Q02U Q03U Q04U Q06U Q10U Q13U Q20U Q26U

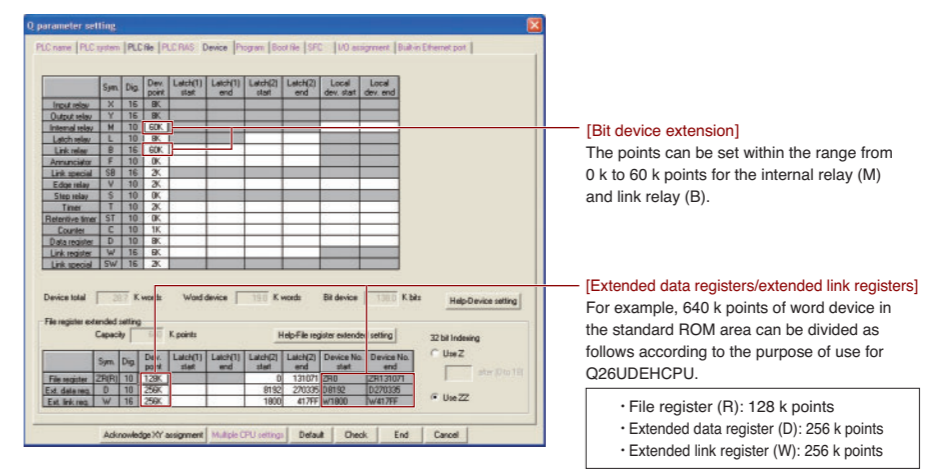

The points can be set within the range from 0 k to 60 k points for the internal relay (M) and link relay (B).

For example, 640 k points of word device in the standard ROM area can be divided as follows according to the purpose of use for Q26UDEHCPU.

- File register (R): 128 k points
- Extended data register (D): 256 k points
- Extended link register (W): 256 k points

Easy Maintenance



Highly compatible with standard Q Series

[Compatibility with Q Series modules]

The standard Q Series modules can be used without modification. Common modules can be used for the existing system and new system, lowering maintenance costs.

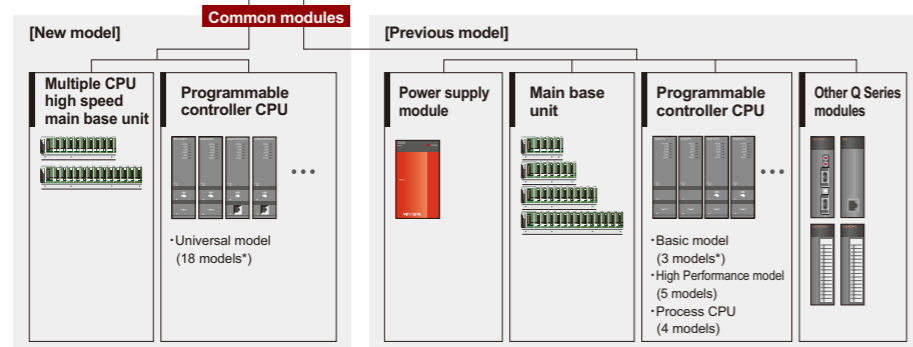
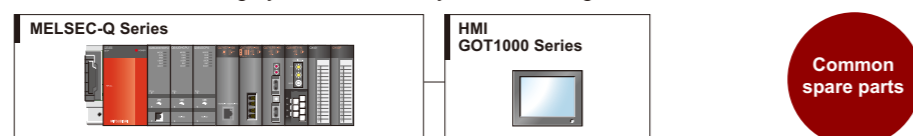

*Q00UJCPU/Q00JCPU is a power supply and 5-slot base unit integrated type CPU.

[Utilizing Q Series programs]

The existing QCPU programs can be utilized by changing the PLC type on GX Developer. Switching of a module to Universal model CPU is performed smoothly.

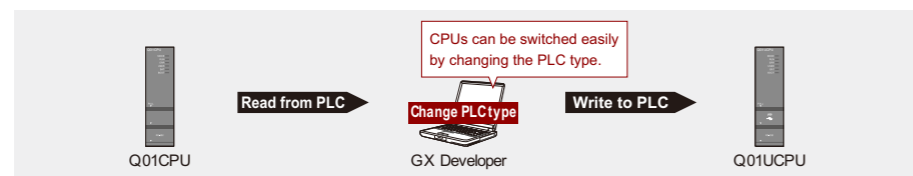

Secure data even after prolonged storage

Program and parameter files are automatically saved in the Flash ROM, which does not require battery backup. This prevents data loss due to dead battery. This function improves battery life. Important information such as device data is also protected in case of dead battery. The data will be backed up in standard ROM, and the backup data automatically returns when power is turned ON.

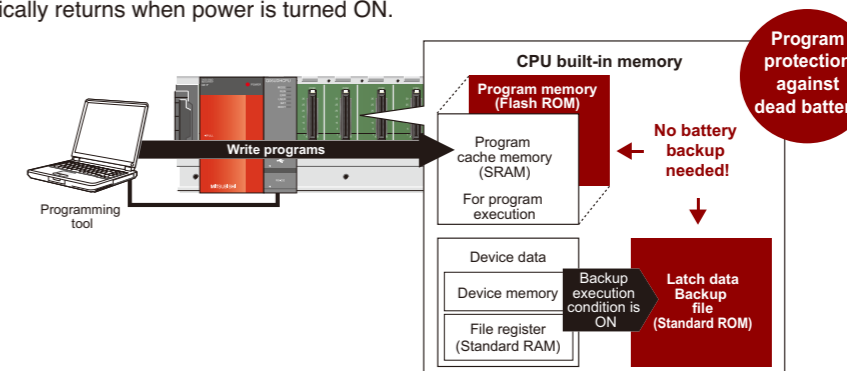

Compatible model: Q00UJ Q00U Q01U Q02U Q03U Q04U Q06U Q10U Q13U Q20U Q26U

Shortened recovery time in system down

Upgraded Function

[CPU module exchange function using a memory card]

All data in the CPU are backed up to a memory card with a simple operation. By backing up data regularly, updated parameters and programs are always stored to a memory card.

In a case of CPU failure, backed up data are restored from the memory card. Thus the management of the backup data is not required and the recovery time from the system down can be shortened.

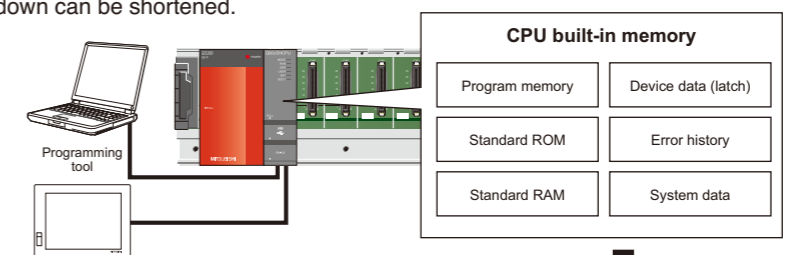

STEP 1 Install a memory card to the CPU and store the backup data to the memory card in advance.

STEP 2 When the CPU is failed, exchange it to the normal CPU and install the memory card with the backup data.

STEP 3 Execute the backup data restoration function from the programming tool, and reset the CPU to recover the data.

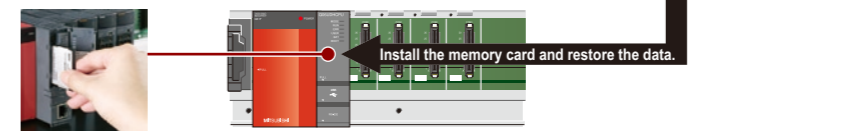

Compatible model: Q02U Q03U Q04U Q06U Q10U Q13U Q20U Q26U

The serial number is indicated on the front of module

Without mounting off the module from the base unit, the serial number can be checked on the front of the module. The serial numbers can be also checked on the screen of GX Developer.

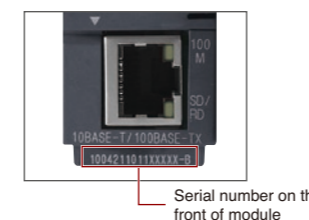

Slot	Type	Series	Model name	Points	I/O No.	Master PLC	Serial No.	Ver.	Product No.
PLC	PLC	Q	Q00UDEHCPU	-	-	-	10042000000000	B	1004211011XXXX-B
0-0	-	-	None	-	-	-	-	-	-
0-1	-	-	None	-	-	-	-	-	-
0-2	-	-	None	-	-	-	-	-	-
0-3	-	-	None	-	-	-	-	-	-
0-4	-	-	None	-	-	-	-	-	-

Displayed on the Product Information List screen of GX Developer

CPU Module Performance Specifications

Item	Q00UJCPU	Q00UCPU	Q01UCPU	Q02UCPU	Q03UDECPU	Q04UDEHCPU		Q06UDEHCPU	Q10UDEHCPU	Q13UDEHCPU	Q20UDEHCPU	Q26UDEHCPU	
	NEW	NEW	NEW		Q03UDCPU	Q04UDHCPU		Q06UDHCPU	Q10UDHCPU	Q13UDHCPU	Q20UDHCPU	Q26UDHCPU	
Control method	Sequence program control method							Sequence program control method					
I/O control mode	Refresh							Refresh					
Program language (sequence control language)	<ul style="list-style-type: none"> Relay symbol language (ladder) Logic symbolic language (list) MELSAP3 (SFC), MELSAP-L Structured text (ST) 							<ul style="list-style-type: none"> Relay symbol language (ladder) Logic symbolic language (list) MELSAP3 (SFC), MELSAP-L Structured text (ST) 					
Peripheral connection port	USB ^(Note 6)	Yes							Yes				
	Ethernet (100BASE-TX/10BASE-T)	No				Q03UDECPU	Q04UDEHCPU		Q06UDEHCPU	Q10UDEHCPU	Q13UDEHCPU	Q20UDEHCPU	Q26UDEHCPU
	RS-232	Yes				Q03UDCPU	Q04UDHCPU		Q06UDHCPU	Q10UDHCPU	Q13UDHCPU	Q20UDHCPU	Q26UDHCPU
Memory card interface	No			Yes				Yes					
Processing speed (sequence instruction)	LD instruction	0.12 μs	0.08 μs	0.06 μs	0.04 μs	0.02 μs	0.0095 μs		0.0095 μs				
	MOV instruction	0.24 μs	0.16 μs	0.12 μs	0.08 μs	0.04 μs	0.019 μs		0.019 μs				
	PC MIX value (instruction/μs) ^(Note 2)	4.92	7.36	9.79	14	28	60		60				
^(Note 1) Floating point addition	0.42 μs	0.30 μs	0.24 μs	0.18 μs	0.12 μs	0.057 μs		0.057 μs					
Total number of instructions ^(Note 3)	822	848		850	858				858				
Operation (floating point operation) instruction	Yes							Yes					
Character string processing instruction	Yes							Yes					
PID instruction	Yes							Yes					
Special function instruction (Trigonometric function, square root, exponential operation, etc.)	Yes							Yes					
Constant scan (Function for keeping regular scan time)	0.5 to 2000 ms (setting available in units of 0.5 ms)							0.5 to 2000 ms (setting available in units of 0.5 ms)					
Program capacity	10 k steps		15 k steps	20 k steps	30 k steps	40 k steps		60 k steps	100 k steps	130 k steps	200 k steps	260 k steps	
Number of I/O device points [X/Y]	8192 points							8192 points					
Number of I/O points [X/Y]	256 points	1024 points		2048 points	4096 points				4096 points				
Internal relay [M]	8192 points							8192 points					
Latch relay [L]	8192 points							8192 points					
Link relay [B]	8192 points							8192 points					
Timer [T]	2048 points							2048 points					
Retentive timer [ST]	0 points							0 points					
Counter [C]	1024 points							1024 points					
Data register [D]	12288 points							12288 points					
Link register [W]	8192 points							8192 points					
Annunciator [F]	2048 points							2048 points					
Edge relay [V]	2048 points							2048 points					
Link special relay [SB]	2048 points							2048 points					
Link special register [SW]	2048 points							2048 points					
File register [R, ZR]	No	65536 points		65536 points ^(Note 5)	98304 points ^(Note 5)	131072 points ^(Note 5)		393216 points ^(Note 5)	524288 points ^(Note 5)	655360 points ^(Note 5)			
Step relay [S]	8192 points							8192 points					
Index register/standard device register [Z]	20 points							20 points					
Index register [Z] (32-bit ZR indexing)	No	Max. 10 points (Z0 to Z18) (Index register [Z] is used in double words.)					Max. 10 points (Z0 to Z18) (Index register [Z] is used in double words.)						
Pointer [P]	512 points			4096 points				4096 points					
Interrupt pointer [I]	128 points			256 points				256 points					
Special relay [SM]	2048 points							2048 points					
Special register [SD]	2048 points							2048 points					
Function input [FX]	16 points							16 points					
Function output [FY]	16 points							16 points					
Function register [FD]	5 points							5 points					
Local device	No	Yes					Yes						
Device initial values	Yes							Yes					

Note 1) The processing speed is the same even when the device is indexed.
 Note 2) The PC MIX value is the average number of instructions such as the basic and data processing instructions executed in 1 μs. A larger value indicates a higher processing speed.
 Note 3) Intelligent function module dedicated instructions are not included.
 Note 4) Indicates the number of points in the default state. This can be changed with the parameter.
 Note 5) Indicates the number of points when using the built-in memory (standard RAM). This can be expanded with the SRAM card or Flash card. (Writing from the program is not possible with the Flash card.) Up to 4184064 points can be used with the SRAM card.
 Note 6) The USB port terminal is mini-B.

General Specifications

General specifications indicate the environmental specifications in which this product can be installed and operated. Unless otherwise specified, the general specifications apply to all products of the Q Series.
Install and operate the Q Series products in the environment indicated in the general specifications.

Item	Specifications					
Operating ambient temperature	0 to 55°C					
Storage ambient temperature	-25 to 75°C (Note 3)					
Operating ambient humidity	5 to 95%RH (Note 4), non-condensing					
Storage ambient humidity	5 to 95%RH (Note 4), non-condensing					
Vibration resistance	Conforms to JIS B 3502, IEC 61131-2		Frequency	Acceleration	Amplitude	Sweep count
		Under intermittent vibration	5 to 9 Hz	—	3.5 mm (0.14 in.)	10 times each in X, Y, Z directions (for 80 min.)
			9 to 150 Hz	9.8 m/s ²	—	
		Under continuous vibration	5 to 9 Hz	—	1.75 mm (0.069 in.)	
9 to 150 Hz	4.9 m/s ²		—			
Shock resistance	Conforms to JIS B 3502, IEC 61131-2 (147 m/s ² , 3 times in each of 3 directions X, Y, Z)					
Operating atmosphere	No corrosive gases					
Operating altitude (Note 5)	2000 m (6562 ft.) or less					
Installation location	Inside control panel					
Overvoltage category (Note 1)	II or less					
Pollution degree (Note 2)	2 or less					
Equipment class	Class I					

Note 1) This indicates the section of the power supply to which the equipment is assumed to be connected between the public electrical power distribution network and the machinery within premises.
Category II applies to equipment for which electrical power is supplied from fixed facilities.
The surge voltage withstand level for up to the rated voltage of 300 V is 2500 V.

Note 2) This index indicates the degree to which conductive material is generated in the environment where the equipment is used.
In pollution degree 2, only non-conductive pollution occurs. However, a temporary conductivity caused by condensation is to be expected.

Note 3) The storage ambient temperature is -20 to 75°C if the system includes the AnS Series modules.

Note 4) The operating ambient humidity and storage ambient humidity are 10 to 90%RH if the system includes the AnS Series modules.

Note 5) Do not use or store the programmable controller under pressure higher than the atmospheric pressure of altitude 0 m.
Doing so can cause a malfunction.
When using the programmable controller under pressure, please consult your local Mitsubishi sales office or representative.

Module Combinations for Multiple CPU System

◎ Possible
○ Possible (multiple CPU high-speed communication not available)
× Impossible

【Multiple CPU high speed main base unit (Q3□DB)】

CPU 1	CPU 2 to 4	Universal model QCPU		High Performance model QCPU	Process CPU	Motion CPU		PC CPU
		Q00U Q01U Q02U	Q03UD (E) Q04UD (E) H Q06UD (E) H Q10UD (E) H Q13UD (E) H Q20UD (E) H Q26UD (E) H iQ Platform	Q02 (H) Q06H Q12H Q25H	Q02PH Q06PH Q12PH Q25PH	Q172D Q173D iQ Platform	Q172H Q173H Q172 Q173	
Universal model QCPU	Q00U Q01U Q02U (Note 2)	×	×	×	×	×	×	○ (Note 1) (Note 3)
	Q03UD (E) Q04UD (E) H Q06UD (E) H Q10UD (E) H Q13UD (E) H Q20UD (E) H Q26UD (E) H iQ Platform	×	◎	○	○	◎	×	○ (Note 1) (Note 3)
High Performance model QCPU	Q02 (H) Q06H Q12H Q25H	×	○	○	○	×	×	○ (Note 1) (Note 3)

【Main base unit other than Q3□DB】

CPU 1	CPU 2 to 4	Universal model QCPU		High Performance model QCPU	Process CPU	Motion CPU		PC CPU
		Q00U Q01U Q02U	Q03UD (E) Q04UD (E) H Q06UD (E) H Q10UD (E) H Q13UD (E) H Q20UD (E) H Q26UD (E) H iQ Platform	Q02 (H) Q06H Q12H Q25H	Q02PH Q06PH Q12PH Q25PH	Q172D Q173D iQ Platform	Q172H Q173H Q172 Q173	
Universal model QCPU	Q00U Q01U Q02U (Note 2)	×	×	×	×	×	○ (Note 4) (Note 6)	○ (Note 1) (Note 3) (Note 6)
	Q03UD (E) Q04UD (E) H Q06UD (E) H Q10UD (E) H Q13UD (E) H Q20UD (E) H Q26UD (E) H iQ Platform	×	○	○	○ (Note 7)	×	×	○ (Note 1) (Note 3) (Note 6)
High Performance model QCPU	Q02 (H) Q06H Q12H Q25H	×	○	○	○ (Note 7)	×	○ (Note 5) (Note 6)	○ (Note 1) (Note 3) (Note 6)

Note 1) For usable model name, version, etc., please contact your local Mitsubishi sales office or representative.

Note 2) Q00U, Q01U, or Q02U does not support multiple CPU high-speed communication.

Note 3) Only one PC CPU can be used.

Note 4) Only one motion CPU can be used.

Note 5) Cannot be used together with Q03UD(E), Q04UD(E)H, Q06UD(E)H, Q10UD(E)H, Q13UD(E)H, Q20UD(E)H, or Q26UD(E)HCPU.

Note 6) The slim type main base unit (Q3□SB) and redundant power main base unit (Q38RB) cannot be used.

Note 7) The slim type main base unit (Q3□SB) cannot be used.

【Comparison between built-in Ethernet port CPU and Ethernet module (QJ71E71-100)】

Function/performance	Built-in Ethernet port CPU QnUDE(H)CPU	Ethernet module QJ71E71-100
Communication speed	100 Mbps	100 Mbps
Communication with GX Developer	Yes	Yes
Communication with GOT	Yes	Yes
MC protocol communication	Yes (Note 1)	Yes
Socket communication	No (Note 2)	Yes (Fixed buffer communication)
Random access buffer communication	No	Yes
Communication by data link instruction	No	Yes
FTP server function	Yes	Yes
E-mail function	No	Yes

Note 1) QnA compatible 3E frame device memory access commands only. Refer to the manual for details.

Note 2) Some differences in function. Refer to the manual for details.

Ensuring an extensive global support network meeting diverse support for today's needs







Complying with international quality assurance standards

All of Mitsubishi Electric's FA component products have acquired the international quality assurance "ISO9001" and environment management system standard "ISO14001" certification. Mitsubishi's products also comply with various safety standards, including UL standards, and shipping standards.

Safety Standards

	CE... Council Directive of the European Communities		UL... Underwriters Laboratories Listing
-----------------------------------------------------------------------------------	-----------------------------------------------------	-----------------------------------------------------------------------------------	-----------------------------------------

Shipping Standards

	LR... Lloyd's Register of Shipping approval		DNV... Norwegian Maritime approval		RINA... Italian Maritime approval
	NK... ClassNK approval		ABS... American Bureau of Shipping approval		BV... Bureau Veritas approval
	GL... Germanischer Lloyd approval				

Global FA Centers

"Mitsubishi Global FA Centers" are located throughout North America, Europe, and Asia to develop products complying with international standards and to provide attentive services.

North American FA Center

MITSUBISHI ELECTRIC AUTOMATION, INC.
500 Corporate Woods Parkway, Vernon Hills, IL 60061, USA
Tel: +1-847-478-2100 / Fax: +1-847-478-0327
Area covered: North America, Mexico, Chile, Brazil

Korean FA Center

MITSUBISHI ELECTRIC AUTOMATION KOREA CO., LTD.
1480-6, Gayang-Dong, Gangseo-Ku, Seoul, 157-200, Korea
Tel: +82-2-3660-9607 / Fax: +82-2-3664-0475
Area covered: Korea

Guangzhou FA Center

MITSUBISHI ELECTRIC AUTOMATION (SHANGHAI) LTD. GUANGZHOU OFFICE
Rm. 1609, North Tower, The Hub Center, No. 1068, Xing Gang East Road, Haizhu District, Guangzhou 510335, China
Tel: +86-20-8923-6713 / Fax: +86-20-8923-6715
Area covered: China

European FA Center

MITSUBISHI ELECTRIC EUROPE B.V. GERMAN BRANCH (Industrial Automation Division)
Gothaer Strasse 8, D-40880 Ratingen, Germany
Tel: +49-2102-486-0 / Fax: +49-2102-486-1120
Area Covered: Europe

Hong Kong FA Center

MITSUBISHI ELECTRIC AUTOMATION (HONG KONG) LTD.
10/F, Manulife Tower, 169 Electric Road, North Point, Hong Kong
Tel: +852-2887-8870 / Fax: +852-2887-7984
Area covered: China

Taiwan FA Center

SETSUYO ENTERPRISE CO., LTD.
6F, No. 105 Wu-Kung 3rd RD, Wu-Ku Hsiang, Taipei Hsien, 248, Taiwan
Tel: +886-2-2299-2499 / Fax: +886-2-2299-2509
Area covered: Taiwan

UK FA Center

MITSUBISHI ELECTRIC EUROPE B.V. UK BRANCH (Customer Technology Center)
Travellers Lane, Hartfield, Hertfordshire, AL10 8XB, UK
Tel: +44-1707-276100 / Fax: +44-1707-278992
Area covered: UK, Ireland

Shanghai FA Center

MITSUBISHI ELECTRIC AUTOMATION (SHANGHAI) LTD.
4/F Zhi Fu Plaza, No. 80 Xin Chang Road, Shanghai 200003, China
Tel: +86-21-2322-2862 / Fax: +86-21-2322-2868
Area covered: China

ASEAN FA Center

MITSUBISHI ELECTRIC ASIA PTE, LTD.
307 Alexandra Road #05-01/02
Mitsubishi Electric Building, Singapore 159943
Tel: +65-6470-2480 / Fax: +65-6476-7439
Area covered: Southeast Asia, India

Central and Eastern Europe FA Center

MITSUBISHI ELECTRIC EUROPE B.V. CZECH BRANCH
Avenir Business Park, Radlicka 714/113a, 15800 Praha 5, Czech Republic
Tel: +420-251-551-470 / Fax: +420-251-551-471
Area covered: Czech Republic, Poland, Hungary, Slovakia

Tianjin FA Center

MITSUBISHI ELECTRIC AUTOMATION (SHANGHAI) LTD. TIANJIN OFFICE
B-2-801/802, Youyi Building, No. 50 Youyi Road, Hexi District, Tianjin 300061, China
Tel: +86-22-2813-1015 / Fax: +86-22-2813-1017
Area covered: China

Thailand FA Center

MITSUBISHI ELECTRIC AUTOMATION (THAILAND) CO., LTD.
Bang-Chan Industrial Estate No. 111, Soi Serithai 54, T.Kannayao, A.Kannayao, Bangkok 10230, Thailand
Tel: +66-02-906-3238 / Fax: +66-02-906-3239
Area covered: Thailand

Russian FA Center

Mitsubishi Electric Europe B.V. - Representative Office in St. Petersburg
Sverdlovskaya Emb., 44, Bld Sch, BC "Benua"; 195027, St.Petersburg, Russia
Tel: +7-812-633-3496 / Fax: +7-812-633-3499
Area covered: Japan, England, Russia

Beijing FA Center

MITSUBISHI ELECTRIC AUTOMATION (SHANGHAI) LTD. BEIJING OFFICE
9/F Office Tower 2, Henderson Center, 18 Jianguomennei Avenue, Dongcheng District, Beijing 100005, China
Tel: +86-10-6518-8830 / Fax: +86-10-6518-8030
Area covered: China

Product List



*Always refer to user's manuals for information on usable modules, restrictions, etc. before using.
*Contact your local Mitsubishi sales office or representative for the latest information on the MELSOFT versions and compatible OS.

CPU, base, power supply

Product	Model	Outline	
CPU	Q00UJCPU NEW	No. of I/O points: 256 points, no. of I/O device points: 8192 points, program capacity: 10 k steps, basic operation processing speed (LD instruction): 0.12 μ s, program memory capacity: 40 KB, peripheral connection ports: USB and RS232, no memory card I/F	
	Q00UCPU NEW	No. of I/O points: 1024 points, no. of I/O device points: 8192 points, program capacity: 10 k steps, basic operation processing speed (LD instruction): 0.08 μ s, program memory capacity: 40 KB, peripheral connection ports: USB and RS232, no memory card I/F	
	Q01UCPU NEW	No. of I/O points: 1024 points, no. of I/O device points: 8192 points, program capacity: 15 k steps, basic operation processing speed (LD instruction): 0.06 μ s, program memory capacity: 60 KB, peripheral connection ports: USB and RS232, no memory card I/F	
	Q02UCPU	No. of I/O points: 2048 points, no. of I/O device points: 8192 points, program capacity: 20 k steps, basic operation processing speed (LD instruction): 0.04 μ s, program memory capacity: 80 KB, peripheral connection ports: USB and RS232, with memory card I/F	
	Q03UDECPU	No. of I/O points: 4096 points, no. of I/O device points: 8192 points, program capacity: 30 k steps, basic operation processing speed (LD instruction): 0.02 μ s, program memory capacity: 120 KB, multiple CPU high-speed communication, peripheral connection ports: USB and Ethernet, with memory card I/F	
	Q03UDCPU	No. of I/O points: 4096 points, no. of I/O device points: 8192 points, program capacity: 30 k steps, basic operation processing speed (LD instruction): 0.02 μ s, program memory capacity: 120 KB, multiple CPU high-speed communication, peripheral connection ports: USB and RS232, with memory card I/F	
	Q04UDEHCPU	No. of I/O points: 4096 points, no. of I/O device points: 8192 points, program capacity: 40 k steps, basic operation processing speed (LD instruction): 0.0095 μ s, program memory capacity: 160 KB, multiple CPU high-speed communication, peripheral connection ports: USB and Ethernet, with memory card I/F	
	Q04UDHCPU	No. of I/O points: 4096 points, no. of I/O device points: 8192 points, program capacity: 40 k steps, basic operation processing speed (LD instruction): 0.0095 μ s, program memory capacity: 160 KB, multiple CPU high-speed communication, peripheral connection ports: USB and RS232, with memory card I/F	
	Q06UDEHCPU	No. of I/O points: 4096 points, no. of I/O device points: 8192 points, program capacity: 60 k steps, basic operation processing speed (LD instruction): 0.0095 μ s, program memory capacity: 240 KB, multiple CPU high-speed communication, peripheral connection ports: USB and Ethernet, with memory card I/F	
	Q06UDHCPU	No. of I/O points: 4096 points, no. of I/O device points: 8192 points, program capacity: 60 k steps, basic operation processing speed (LD instruction): 0.0095 μ s, program memory capacity: 240 KB, multiple CPU high-speed communication, peripheral connection ports: USB and RS232, with memory card I/F	
	Q10UDEHCPU NEW	No. of I/O points: 4096 points, no. of I/O device points: 8192 points, program capacity: 100 k steps, basic operation processing speed (LD instruction): 0.0095 μ s, program memory capacity: 400 KB, multiple CPU high-speed communication, peripheral connection ports: USB and Ethernet, with memory card I/F	
	Q10UDHCPU NEW	No. of I/O points: 4096 points, no. of I/O device points: 8192 points, program capacity: 100 k steps, basic operation processing speed (LD instruction): 0.0095 μ s, program memory capacity: 400 KB, multiple CPU high-speed communication, peripheral connection ports: USB and RS232, with memory card I/F	
	Q13UDEHCPU	No. of I/O points: 4096 points, no. of I/O device points: 8192 points, program capacity: 130 k steps, basic operation processing speed (LD instruction): 0.0095 μ s, program memory capacity: 520 KB, multiple CPU high-speed communication, peripheral connection ports: USB and Ethernet, with memory card I/F	
	Q13UDHCPU	No. of I/O points: 4096 points, no. of I/O device points: 8192 points, program capacity: 130 k steps, basic operation processing speed (LD instruction): 0.0095 μ s, program memory capacity: 520 KB, multiple CPU high-speed communication, peripheral connection ports: USB and RS232, with memory card I/F	
	Q20UDEHCPU NEW	No. of I/O points: 4096 points, no. of I/O device points: 8192 points, program capacity: 200 k steps, basic operation processing speed (LD instruction): 0.0095 μ s, program memory capacity: 800 KB, multiple CPU high-speed communication, peripheral connection ports: USB and Ethernet, with memory card I/F	
	Q20UDHCPU NEW	No. of I/O points: 4096 points, no. of I/O device points: 8192 points, program capacity: 200 k steps, basic operation processing speed (LD instruction): 0.0095 μ s, program memory capacity: 800 KB, multiple CPU high-speed communication, peripheral connection ports: USB and RS232, with memory card I/F	
	Q26UDEHCPU	No. of I/O points: 4096 points, no. of I/O device points: 8192 points, program capacity: 260 k steps, basic operation processing speed (LD instruction): 0.0095 μ s, program memory capacity: 1040 KB, multiple CPU high-speed communication, peripheral connection ports: USB and Ethernet, with memory card I/F	
	Q26UDHCPU	No. of I/O points: 4096 points, no. of I/O device points: 8192 points, program capacity: 260 k steps, basic operation processing speed (LD instruction): 0.0095 μ s, program memory capacity: 1040 KB, multiple CPU high-speed communication, peripheral connection ports: USB and RS232, with memory card I/F	
	Battery	Q6BAT	Replacement battery
		Q7BAT	Replacement large-capacity battery
Q7BAT-SET		Large-capacity battery with holder for mounting CPU	
Q8BAT		Replacement large-capacity battery module	
Q8BAT-SET		Large-capacity battery module with CPU connection cable	
Memory card		Q2MEM-1MBS	SRAM memory card, capacity: 1 MB
	Q2MEM-2MBS	SRAM memory card, capacity: 2 MB	
	Q3MEM-4MBS	SRAM memory card, capacity: 4 MB	
	Q3MEM-4MBS-SET	SRAM memory card with cover, capacity: 4 MB	
	Q3MEM-8MBS	SRAM memory card, capacity: 8 MB	
	Q3MEM-8MBS-SET	SRAM memory card with cover, capacity: 8 MB	
	Q2MEM-2MBF	Linear Flash memory card, capacity: 2 MB	
	Q2MEM-4MBF	Linear Flash memory card, capacity: 4 MB	
	Q2MEM-8MBA	ATA card, capacity: 8 MB	
	Q2MEM-16MBA	ATA card, capacity: 16 MB	
Q2MEM-32MBA	ATA card, capacity: 32 MB		

CPU, base, power supply

	Product	Model	Outline
CPU	Memory card adapter	Q2MEM-ADP	Adapter for Q2MEM memory card's standard PCMCIA slot
	SRAM card battery	Q2MEM-BAT	Replacement battery for Q2MEM-1MBS and Q2MEM-2MBS
		Q3MEM-BAT	Replacement battery for Q3MEM-4MBS and Q3MEM-8MBS
	Connection cable	QC30R2	RS-232 cable for connecting personal computer and CPU, 3 m (between mini-DIN6P and Dsub9P)
	Cable disconnection prevention holder	Q6HLD-R2	Holder for preventing RS-232 cable (programmable controller CPU connection) disconnection
Base	Main base	Q33B	3 slots, 1 power supply module required, for Q Series modules
		Q35B	5 slots, 1 power supply module required, for Q Series modules
		Q38B	8 slots, 1 power supply module required, for Q Series modules
		Q312B	12 slots, 1 power supply module required, for Q Series modules
		Multiple CPU high speed main base	Q38DB
		Q312DB	12 slots, 1 power supply module required, for Q Series modules
	Slim type main base	Q32SB	2 slots, 1 slim type power supply module required, for Q Series modules
		Q33SB	3 slots, 1 slim type power supply module required, for Q Series modules
		Q35SB	5 slots, 1 slim type power supply module required, for Q Series modules
	Redundant power main base	Q38RB	8 slots, 2 redundant power supply modules required, for Q Series modules
	Extension base	Q63B	3 slots, 1 power supply module required, for Q Series modules
		Q65B	5 slots, 1 power supply module required, for Q Series modules
		Q68B	8 slots, 1 power supply module required, for Q Series modules
		Q612B	12 slots, 1 power supply module required, for Q Series modules
		Q52B	2 slots, power supply module not required, for Q Series modules
		Q55B	5 slots, power supply module not required, for Q Series modules
	Redundant power extension base	Q68RB	8 slots, 2 redundant power supply modules required, for Q Series modules
	Extension cable	QC05B	0.45 m cable for connecting extension base unit
		QC06B	0.6 m cable for connecting extension base unit
		QC12B	1.2 m cable for connecting extension base unit
QC30B		3 m cable for connecting extension base unit	
QC50B		5 m cable for connecting extension base unit	
QC100B		10 m cable for connecting extension base unit	
DIN rail mounting adapter	Q6DIN1	DIN rail mounting adapter for Q38B, Q312B, Q68B, Q612B, Q38RB, Q68RB, Q65WRB, Q38DB, and Q312DB	
	Q6DIN2	DIN rail mounting adapter for Q35B, Q65B, and Q00UJCPU	
	Q6DIN3	DIN rail mounting adapter for Q32SB, Q33SB, Q35SB, Q33B, Q52B, Q55B, and Q63B	
	Q6DIN1A	DIN rail mounting adapter (with vibration-proofing bracket set) for Q3□B, Q5□B, Q6□B, Q38RB, Q68RB, and Q65WRB	
Blank cover	QG60	Blank cover for I/O slot	
Power supply	Q61P	Input voltage: 100 to 240 V AC, output voltage: 5 V DC, output current: 6 A	
	Q62P	Input voltage: 100 to 240 V AC, output voltage: 5/24 V DC, output current: 3/0.6 A	
	Q63P	Input voltage: 24 V DC, output voltage: 5 V DC, output current: 6 A	
	Q64PN ^(Note 8)	Input voltage: 100 to 240 V AC, output voltage: 5 V DC, output current: 8.5 A	
Slim type power supply	Q61SP	Input voltage: 100 to 240 V AC, output voltage: 5 V DC, output current: 2 A	
Redundant power supply	Q63RP	Input voltage: 24 V DC, output voltage: 5 V DC, output current: 8.5 A	
	Q64RP	Input voltage: 100 to 120/200 to 240 V AC, output voltage: 5 V DC, output current: 8.5 A	
Power Supply with Life Detection NEW	Q61P-D	Input voltage: 100 to 240 V AC, output voltage: 5 V DC, output current: 6A	

I/O module

	Product	Model	Outline
Input	AC	QX10	16 points, 100 to 120 V AC, response time: 20 ms, 16 points/common, 18-point terminal block
		QX10-TS NEW	16 points, 100 to 120 V AC, response time: 20 ms, 16 points/common, 18-point spring clamp terminal block
		QX28	8 points, 100 to 240 V AC, response time: 20 ms, 8 points/common, 18-point terminal block
	DC (Positive common) ^(Note 1)	QX40	16 points, 24 V DC, response time: 1/5/10/20/70 ms, 16 points/common, positive common, 18-point terminal block
		QX40-TS NEW	16 points, 24 V DC, response time: 1/5/10/20/70 ms, 16 points/common, positive common, 18-point spring clamp terminal block
		QX40-S1	16 points, 24 V DC, response time: 0.1/0.2/0.4/0.6/1 ms, 16 points/common, positive common, 18-point terminal block
		QX40H NEW	16 points, 24 V DC, response time: 0/0.1/0.2/0.4/0.6/1 ms, 8 points/common, positive common, 18-point terminal block
		QX41 ^(Note 2)	32 points, 24 V DC, response time: 1/5/10/20/70 ms, 32 points/common, positive common, 40-pin connector
		QX41-S1 ^(Note 2)	32 points, 24 V DC, response time: 0.1/0.2/0.4/0.6/1 ms, 32 points/common, positive common, 40-pin connector
	DC (Negative common) ^(Note 1)	QX42 ^(Note 2)	64 points, 24 V DC, response time: 1/5/10/20/70 ms, 32 points/common, positive common, 40-pin connector
		QX42-S1 ^(Note 2)	64 points, 24 V DC, response time: 0.1/0.2/0.4/0.6/1 ms, 32 points/common, positive common, 40-pin connector
	AC/DC ^(Note 1)	QX50	16 points, 48 V AC/DC, response time: 20 ms, 16 points/common, positive/negative common, 18-point terminal block
	DC sensor	QX70	16 points, 5/12 V DC, response time: 1/5/10/20/70 ms, 16 points/common, positive/negative common, 18-point terminal block
		QX70H NEW	16 points, 5 V DC, response time: 0/0.1/0.2/0.4/0.6/1 ms, 8 points/common, positive common, 18-point terminal block
		QX71	32 points, 5/12 V DC, response time: 1/5/10/20/70 ms, 32 points/common, positive/negative common, 40-pin connector
	DC (Negative common) ^(Note 1)	QX72	64 points, 5/12 V DC, response time: 1/5/10/20/70 ms, 32 points/common, positive/negative common, 40-pin connector
		QX80	16 points, 24 V DC, response time: 1/5/10/20/70 ms, 16 points/common, negative common, 18-point terminal block
		QX80-TS NEW	16 points, 24 V DC, response time: 1/5/10/20/70 ms, 16 points/common, negative common, 18-point spring clamp terminal block
QX80H NEW		16 points, 24 V DC, response time: 0/0.1/0.2/0.4/0.6/1 ms, 8 points/common, negative common, 18-point terminal block	
QX81 ^(Note 3)		32 points, 24 V DC, response time: 1/5/10/20/70 ms, 32 points/common, negative common, 37-pin D-sub connector	
QX82 ^(Note 2)		64 points, 24 V DC, response time: 1/5/10/20/70 ms, 32 points/common, negative common, 40-pin connector	
QX82-S1 ^(Note 2)		64 points, 24 V DC, response time: 0.1/0.2/0.4/0.6/1 ms, 32 points/common, negative common, 40-pin connector	
QX90H NEW		16 points, 5 V DC, response time: 0/0.1/0.2/0.4/0.6/1 ms, 8 points/common, negative common, 18-point terminal block	
Relay	QY10	16 points, 24 V DC/240 V AC, 2 A/point, 8 A/common, response time: 12 ms, 16 points/common, 18-point terminal block	
	QY10-TS NEW	16 points, 24 V DC/240 V AC, 2 A/point, 8 A/common, response time: 12 ms, 16 points/common, 18-point spring clamp terminal block	
	QY18A	8 points, 24 V DC/240 V AC, 2 A/point, response time: 12 ms, 18-point terminal block, all points independent	
	Triac	QY22	16 points, 100 to 240 V AC, 0.6 A/point; 4.8 A/common, response time: 1 ms + 0.5 cycle, 16 points/common, 18-point terminal block, with surge suppressor
		QY40P	16 points, 12 to 24 V DC, 0.1 A/point, 1.6 A/common, response time: 1 ms, 16 points/common, sink type, 18-point terminal block, with thermal and short-circuit protection and surge suppressor
	Transistor (Sink)	QY40P-TS NEW	16 points, 12 to 24 V DC, 0.1 A/point, 1.6 A/common, response time: 1 ms, 16 points/common, sink type, 18-point spring clamp terminal block, with thermal and short-circuit protection and surge suppressor
QY41P ^(Note 2)		32 points, 12 to 24 V DC, 0.1 A/point, 2 A/common, response time: 1 ms, 32 points/common, sink type, 40-pin connector, with thermal and short-circuit protection and surge suppressor	
QY42P ^(Note 2)		64 points, 12 to 24 V DC, 0.1 A/point, 2 A/common, response time: 1 ms, 32 points/common, sink type, 40-pin connector, with thermal and short-circuit protection and surge suppressor	
QY50		16 points, 12 to 24 V DC, 0.5 A/point, 4 A/common, response time: 1 ms, 16 points/common, sink type, 18-point terminal block, with surge suppressor and fuse	
Transistor (Independent)	QY68A	8 points, 5 to 24 V DC, 2 A/point, 8 A/module, response time: 10 ms, sink/source type, 18-point terminal block, with surge suppressor, all points independent	
TTL CMOS	QY70	16 points, 5 to 12 V DC, 16 mA/point, 256 mA/common, response time: 0.5 ms, 16 points/common, sink type, 18-point terminal block, with fuse	
	QY71 ^(Note 2)	32 points, 5 to 12 V DC, 16 mA/point, 512 mA/common, response time: 0.5 ms, 32 points/common, sink type, 40-pin connector, with fuse	
	Transistor (Source)	QY80	16 points, 12 to 24 V DC, 0.5 A/point, 4 A/common, response time: 1 ms, 16 points/common, source type, 18-point terminal block, with surge suppressor and fuse
QY80-TS NEW		16 points, 12 to 24 V DC, 0.5 A/point, 4 A/common, response time: 1 ms, 16 points/common, source type, 18-point spring clamp terminal block, with surge suppressor and fuse	
QY81P		32 points, 12 to 24 V DC, 0.1 A/point, 2 A/common, response time: 1 ms, 32 points/common, source type, 37-pin D-sub connector, with thermal and short-circuit protection and surge suppressor	
I/O	DC input/transistor output	QH42P* ^(Note 2)	Input: 32 points, 24 V DC, response time: 1/5/10/20/70 ms, 32 points/common, positive common; output: 32 points, 12 to 24 V DC, 0.1 A/point, 2 A/common, response time: 1 ms, 32 points/common, sink type; 40-pin connector, with thermal and short-circuit protection and surge suppressor
		QX48Y57	Input: 8 points, 24 V DC, response time: 1/5/10/20/70 ms, 8 points/common, positive common; output: 7 points, 12 to 24 V DC, 0.5 A/point, 2 A/common, response time: 1 ms, 7 points/common, sink type; 18-point terminal block, with surge suppressor and fuse
		QX41Y41P* ^(Note 2)	Input: 32 points, 24 V DC, response time: 1/5/10/20/70 ms, 32 points/common, positive common; output: 32 points, 12 to 24 V DC, 0.1 A/point, 2 A/common, response time: 1 ms, 32 points/common, sink type; 40-pin connector, with thermal and short-circuit protection and surge suppressor
Interrupt module	QI60	16 points, 24 V DC, response time: 0.1/0.2/0.4/0.6/1 ms, 16 points/common, 18-point terminal block	

*Number of occupied I/O points differs.
QH42P: 32 points
QX41Y41P: 64 points (32 points of first half: input, 32 points of latter half: output)

I/O module

Product	Model	Outline	
Connector	A6CON1	32-point connector soldering type (40-pin connector)	
	A6CON2	32-point connector crimp-contact type (40-pin connector)	
	A6CON3	32-point connector pressure-displacement (flat cable) type (40-pin connector)	
	A6CON4	32-point connector soldering type (40-pin connector, cable connectable in bidirection)	
	A6CON1E	32-point connector soldering type (37-pin D-sub connector)	
	A6CON2E	32-point connector crimp-contact type (37-pin D-sub connector)	
Spring clamp terminal block	A6CON3E	32-point connector pressure-displacement (flat cable) type (37-pin D-sub connector)	
	Q6TE-18S	For 16-point I/O modules, 0.3 to 1.5 mm ² (22 to 16 AWG)	
Terminal block adapter	Q6TA32	For 32-point I/O modules, 0.5 mm ² (20 AWG)	
	Q6TA32-TOL	Q6TA32 dedicated tool	
Connector/terminal block conversion module	A6TBXY36	For positive common input modules and sink output modules (standard type)	
	A6TBXY54	For positive common input modules and sink output modules (2-wire type)	
	A6TBX70	For positive common input modules (3-wire type)	
	A6TBX36-E	For negative common input modules (standard type)	
	A6TBX54-E	For negative common input modules (2-wire type)	
	A6TBX70-E	For negative common input modules (3-wire type)	
	A6TBY36-E	For source output modules (standard type)	
	A6TBY54-E	For source output modules (2-wire type)	
	Cable	AC05TB	For A6TBXY36, A6TBXY54, and A6TBX70 (positive common/sink type); 0.5 m
		AC10TB	For A6TBXY36, A6TBXY54, and A6TBX70 (positive common/sink type); 1 m
AC20TB		For A6TBXY36, A6TBXY54, and A6TBX70 (positive common/sink type); 2 m	
AC30TB		For A6TBXY36, A6TBXY54, and A6TBX70 (positive common/sink type); 3 m	
AC50TB		For A6TBXY36, A6TBXY54, and A6TBX70 (positive common/sink type); 5 m	
AC80TB		For A6TBXY36, A6TBXY54, and A6TBX70 (positive common/sink type); 8 m *Common current 0.5 A or lower	
AC100TB		For A6TBXY36, A6TBXY54, and A6TBX70 (positive common/sink type); 10 m *Common current 0.5 A or lower	
AC05TB-E		For A6TBX36-E, A6TBY36-E, A6TBX54-E, A6TBY54-E, and A6TBX70-E (negative common/source type); 0.5 m	
AC10TB-E		For A6TBX36-E, A6TBY36-E, A6TBX54-E, A6TBY54-E, and A6TBX70-E (negative common/source type); 1 m	
AC20TB-E		For A6TBX36-E, A6TBY36-E, A6TBX54-E, A6TBY54-E, and A6TBX70-E (negative common/source type); 2 m	
AC30TB-E		For A6TBX36-E, A6TBY36-E, A6TBX54-E, A6TBY54-E, and A6TBX70-E (negative common/source type); 3 m	
AC50TB-E		For A6TBX36-E, A6TBY36-E, A6TBX54-E, A6TBY54-E, and A6TBX70-E (negative common/source type); 5 m	
Relay terminal module		A6TE2-16SRN	For 40-pin connector 24 V DC transistor output modules (sink type)
		Cable	AC06TE
AC10TE	For A6TE2-16SRN, 1 m		
AC30TE	For A6TE2-16SRN, 3 m		
AC50TE	For A6TE2-16SRN, 5 m		
AC100TE	For A6TE2-16SRN, 10 m		

Analog I/O module

Product	Model	Outline
Analog input	Voltage input	Q68ADV 8 channels; input: -10 to 10 V DC; output (resolution): 0 to 4000, -4000 to 4000, 0 to 12000, -12000 to 12000, 0 to 16000, -16000 to 16000; conversion speed: 80 μs/channel; 18-point terminal block
	Current input	Q62AD-DGH 2 channels; input: 4 to 20 mA DC; output (resolution): 0 to 32000, 0 to 64000; conversion speed: 10 ms/2 channels; 18-point terminal block; channel isolated; supplies power to 2-wire transmitter
		Q66AD-DG (Note 5) 6 channels; input: 4 to 20 mA DC (when 2-wire transmitter is connected), 0 to 20 mA DC; output (resolution): 0 to 4000, 0 to 12000; conversion speed: 10 ms/channel; 40-pin connector; channel isolated; supplies power to 2-wire transmitter
		Q68ADI 8 channels; input: 0 to 20 mA DC; output (resolution): 0 to 4000, -4000 to 4000, 0 to 12000, -12000 to 12000, 0 to 16000, -16000 to 16000; conversion speed: 80 μs/channel; 18-point terminal block
	Voltage/current input	Q64AD 4 channels; input: -10 to 10 V DC, 0 to 20 mA DC; output (resolution): 0 to 4000, -4000 to 4000, 0 to 12000, -12000 to 12000, 0 to 16000, -16000 to 16000; conversion speed: 80 μs/channel; 18-point terminal block
		Q64AD-GH 4 channels; input: -10 to 10 V DC, 0 to 20 mA DC; output (resolution): 0 to 32000, -32000 to 32000, 0 to 64000, -64000 to 64000; conversion speed: 10 ms/4 channels; 18-point terminal block, channel isolated
Q68AD-G (Note 5) 8 channels; input: -10 to 10 V DC, 0 to 20 mA DC; output (resolution): 0 to 4000, -4000 to 4000, 0 to 12000, -12000 to 12000, 0 to 16000, -16000 to 16000; conversion speed: 80 μs/channel; 40-pin connector, channel isolated		
Analog output	Voltage output	Q68DAVN 8 channels; input (resolution): 0 to 4000, -4000 to 4000, 0 to 12000, -12000 to 12000, -16000 to 16000; conversion speed: 80 μs/channel; 18-point terminal block, transformer isolation between power supply and output
	Current output	Q68DAIN 8 channels; input (resolution): 0 to 4000, -4000 to 4000, 0 to 12000, -12000 to 12000; output: 0 to 20 mA DC; conversion speed: 80 μs/channel; 18-point terminal block, transformer isolation between power supply and output
		Q62DAN 2 channels; input (resolution): 0 to 4000, -4000 to 4000, 0 to 12000, -12000 to 12000, -16000 to 16000; output: -10 to 10 V DC, 0 to 20 mA DC; conversion speed: 80 μs/channel; 18-point terminal block, transformer isolation between power supply and output
	Voltage/current output	Q62DA-FG 2 channels; input (resolution): 0 to 12000, -12000 to 12000, -16000 to 16000; output: -12 to 12 V DC, 0 to 22 mA DC; conversion speed: 10 ms/2 channels; 18-point terminal block; channel isolated
		Q64DAN 4 channels; input (resolution): 0 to 4000, -4000 to 4000, 0 to 12000, -12000 to 12000, -16000 to 16000; output: -10 to 10 V DC, 0 to 20 mA DC; conversion speed: 80 μs/channel; 18-point terminal block; transformer isolation between power supply and output
	Q66DA-G (Note 5) 6 channels; input (resolution): 0 to 4000, -4000 to 4000, 0 to 12000, -12000 to 12000, -16000 to 16000; output: -12 to 12 V DC, 0 to 22 mA DC; conversion speed: 6 ms/channel; 40-pin connector; channel isolated	
Temperature input	RTD	Q64RD 4 channels, platinum RTD (Pt100 [JIS C1604-1997, IEC 751 1983], JPt100 [JIS C1604-1981]), conversion speed: 40 ms/channel, 18-point terminal block
		Q64RD-G 4 channels, RTD (Pt100 [JIS C1604-1997, IEC 751 1983], JPt100 [JIS C1604-1981], Ni100 Ω [DIN43760 1987]), conversion speed: 40 ms/channel, 18-point terminal block, channel isolated
		Q68RD3-G (Note 5) 8 channels, RTD (3-wire type, Pt100 [JIS C1604-1997, IEC 751 1983], JPt100 [JIS C1604-1981]), Ni100 Ω [DIN43760 1987]), conversion speed: 320 ms/8 channels, 40-pin connector, channel isolated
	Thermocouple	Q64TD 4 channels, thermocouple (JIS C1602-1995), conversion speed: 40 ms/channel, 18-point terminal block
		Q64TDV-GH 4 channels, thermocouple (JIS C1602-1995), micro voltage (-100 to 100 mV), conversion speed: sampling cycle x 3, sampling cycle: 20 ms/channel, 18-point terminal block
		Q68TD-G-H01 (Note 5) (Note 7) 8 channels, thermocouple (JIS C1602-1995, IEC 60584-1 [1995], IEC 60584-2 [1982]), conversion speed: 320 ms/8 channels, 40-pin connector
Q68TD-G-H02 (Note 5) (NEW) 8 channels, thermocouple (JIS C1602-1995, IEC 60584-1 [1995], IEC 60584-2 [1982]), conversion speed: 640 ms/8 channels, 40-pin connector		
Temperature control	Platinum RTD	Q64TCRT 4 channels, platinum RTD (Pt100, JPt100), no heater disconnection detection, sampling cycle: 0.5 s/4 channels, 18-point terminal block
		Q64TCRTBW 4 channels, platinum RTD (Pt100, JPt100), with heater disconnection detection, sampling cycle: 0.5 s/4 channels, two 18-point terminal blocks
	Thermocouple	Q64CTT 4 channels, thermocouple (K, J, T, B, S, E, R, N, U, L, PLII, W5Re/W26Re), no heater disconnection detection, sampling cycle: 0.5 s/4 channels, 18-point terminal block
		Q64CTTBW 4 channels, thermocouple (K, J, T, B, S, E, R, N, U, L, PLII, W5Re/W26Re), with heater disconnection detection, sampling cycle: 0.5 s/4 channels, two 18-point terminal blocks
Loop control	Q62HLC 2 channels, input: thermocouple/micro voltage/voltage/current, conversion speed (input): 25 ms/2 channels, sampling cycle: 25 ms/2 channels; output: 4 to 20 mA DC, conversion speed (output): 25 ms/2 channels; 18-point terminal block, with 5 PID control modes	

Pulse I/O and positioning module

Product	Model	Outline		
Channel isolated pulse input	QD60P8-G	8 channels, 30 kpps/10 kpps/1 kpps/100 pps/50 pps/10 pps/1 pps/0.1 pps, count input signal: 5/12 to 24 V DC		
High-speed counter	QD62 (Note 2)	2 channels; 200/100/10 kpps; count input signal: 5/12/24 V DC; external input: 5/12/24 V DC; coincidence output: transistor (sink), 12/24 V DC, 0.5 A/point, 2 A/common; 40-pin connector		
	QD62D (Note 2)	2 channels; 500/200/100/10 kpps; count input signal: EIA standards RS-422-A (differential line driver), external input: 5/12/24 V DC; coincidence output: transistor (sink), 12/24 V DC, 0.5 A/point, 2 A/common; 40-pin connector		
	QD62E (Note 2)	2 channels; 200/100/10 kpps; count input signal: 5/12/24 V DC; external input: 5/12/24 V DC; coincidence output: transistor (source), 12/24 V DC, 0.1 A/point, 0.4 A/common; 40-pin connector		
	QD63P6 (Note 4)	6 channels, 200/100/10 kpps, count input signal: 5 V DC, 40-pin connector		
Positioning	Open collector output (Note 4)	QD75P1	1 axis; control unit: mm, inch, degree, pulse; no. of positioning data: 600/axis; max. output pulse: 200 kpps; 40-pin connector	
		QD75P2	2 axes; 2-axis linear interpolation, 2-axis circular interpolation; control unit: mm, inch, degree, pulse; no. of positioning data: 600/axis; max. output pulse: 200 kpps; 40-pin connector	
		QD75P4	4 axes; 2-/3-/4-axis linear interpolation, 2-axis circular interpolation; control unit: mm, inch, degree, pulse; no. of positioning data: 600/axis; max. output pulse: 200 kpps; 40-pin connector	
		QD70P4	4 axes, control unit: pulse, no. of positioning data: 10/axis, max. output pulse: 200 kpps, 40-pin connector	
		QD70P8	8 axes, control unit: pulse, no. of positioning data: 10/axis, max. output pulse: 200 kpps, 40-pin connector	
	Differential output (Note 4)	QD75D1	1 axis; control unit: mm, inch, degree, pulse; no. of positioning data: 600/axis; max. output pulse: 1 Mpps; 40-pin connector	
		QD75D2	2 axes; 2-axis linear interpolation, 2-axis circular interpolation; control unit: mm, inch, degree, pulse; no. of positioning data: 600/axis; max. output pulse: 1 Mpps; 40-pin connector	
		QD75D4	4 axes; 2-/3-/4-axis linear interpolation, 2-axis circular interpolation; control unit: mm, inch, degree, pulse; no. of positioning data: 600/axis; max. output pulse: 1 Mpps; 40-pin connector	
		QD70D4	4 axes, control unit: pulse, no. of positioning data: 10/axis, max. output pulse: 4 Mpps, 40-pin connector	
	With SSCNET connectivity (Note 2)	QD75M1	1 axis; control unit: mm, inch, degree, pulse; no. of positioning data: 600/axis; 40-pin connector	
		QD75M2	2 axes; 2-axis linear interpolation, 2-axis circular interpolation; control unit: mm, inch, degree, pulse; no. of positioning data: 600/axis; 40-pin connector	
		QD75M4	4 axes; 2-/3-/4-axis linear interpolation, 2-axis circular interpolation; control unit: mm, inch, degree, pulse; no. of positioning data: 600/axis; 40-pin connector	
		With SSCNET III connectivity (Note 2)	QD75MH1	1 axis; control unit: mm, inch, degree, pulse; no. of positioning data: 600/axis; 40-pin connector; with SSCNET III connectivity
			QD75MH2	2 axes; 2-axis linear interpolation, 2-axis circular interpolation; control unit: mm, inch, degree, pulse; no. of positioning data: 600/axis; 40-pin connector; with SSCNET III connectivity
			QD75MH4	4 axes; 2-/3-/4-axis linear interpolation, 2-axis circular interpolation; control unit: mm, inch, degree, pulse; no. of positioning data: 600/axis; 40-pin connector; with SSCNET III connectivity
			QD74MH8 (NEW)	8 axes, control unit: pulse, no. of positioning data: 32/axis, with SSCNET III connectivity
		QD74MH16 (NEW)	16 axes, control unit: pulse, no. of positioning data: 32/axis, with SSCNET III connectivity	
		Open collector output with built-in counter function (Note 4)	QD72P3C3	Positioning: 3 axes, control unit: pulse, no. of positioning data: 1/axis, max. output pulse: 100 kpps, counter: 3 channels, 100 kpps, count input signal: 5/24 V DC, 40-pin connector

Information module

Product	Model	Outline	
MES interface	QJ71MES96	MES interface module *MX MESInterface and CompactFlash card are required.	
	Option	GT05-MEM-128MC	128 MB CompactFlash card
		GT05-MEM-256MC	256 MB CompactFlash card
Ethernet	QJ71E71-100	10BASE-T/100BASE-TX	
	QJ71E71-B2	10BASE2	
	QJ71E71-B5	10BASE5	
Serial communication	QJ71C24N	RS-232: 1 channel, RS-422/485: 1 channel, total transmission speed of 2 channels: 230.4 kbps	
	QJ71C24N-R2	RS-232: 2 channels, total transmission speed of 2 channels: 230.4 kbps	
	QJ71C24N-R4	RS-422/485: 2 channels, total transmission speed of 2 channels: 230.4 kbps	
Intelligent communication	QD51	BASIC program execution module, RS-232: 2 channels	
	QD51-R24	BASIC program execution module, RS-232: 1 channel, RS-422/485: 1 channel	
	SW□IVD-AD51HP (Note 6)	Software package for QD51, AD51H-S3, and A1SD51S	

Control network module

CC-Link IE Controller Network	QJ71GP21-SX	Multi-mode fiber optic cable, dual loop, controller network (control/normal station)	
	QJ71GP21S-SX	Multi-mode fiber optic cable, dual loop, controller network (control/normal station), with external power supply function	
MELSECNET/H	Optical loop (SI)	QJ71LP21-25	SI/QSI/H-PCF/ broadband H-PCF fiber optic cable, dual loop, controller network (control/normal station) or remote I/O network (remote mater station)
		QJ71LP21S-25	SI/QSI/H-PCF/ broadband H-PCF fiber optic cable, dual loop, controller network (control/normal station) or remote I/O network (remote mater station), with external power supply function
		QJ72LP25-25	SI/QSI/H-PCF/ broadband H-PCF fiber optic cable, dual loop, remote I/O network (remote I/O station)
	Optical loop (GI)	QJ71LP21G	GI-50/125 fiber optic cable, dual loop, controller network (control/normal station) or remote I/O network (remote master station)
		QJ72LP25G	GI-50/125 fiber optic cable, dual loop, remote I/O network (remote I/O station)
		QJ71LP21GE	GI-62.5/125 fiber optic cable, dual loop, controller network (control/normal station) or remote I/O network (remote master station)
		QJ72LP25GE	GI-62.5/125 fiber optic cable, dual loop, remote I/O network (remote I/O station)
	Coaxial bus	QJ71BR11	3C-2V/5C-2V coaxial cable, single bus, controller network (control/normal station) or remote I/O network (remote master station)
QJ72BR15		3C-2V/5C-2V coaxial cable, single bus, remote I/O network (remote I/O station)	
Twist bus	QJ71NT11B (NEW)	Twisted pair cable, single bus, controller network (control/normal station)	
CC-Link	QJ61BT11N	Master/local station, CC-Link Ver. 2 compatible	
CC-Link/LT	QJ61CL12	Master station	
FL-net (OPCN-2)	Ver. 2.00	QJ71FL71-T-F01	10BASE-T, 100BASE-TX
		QJ71FL71-B2-F01	10BASE2
		QJ71FL71-B5-F01	10BASE5
	Ver. 1.00	QJ71FL71-T	10BASE-T
		QJ71FL71-B2	10BASE2
	QJ71FL71-B5	10BASE5	
AS-i	QJ71AS92	Master station, AS-Interface Specification Version 2.11 compatible	

PC interface board

Product	Model	Outline	
CC-Link IE controller network	Q80BD-J71GP21-SX	PCI bus/PCI-X bus, Japanese/English OS compatible, multi-mode fiber optic cable, dual loop, controller network (control/normal station)	
	Q80BD-J71GP21S-SX	PCI bus/PCI-X bus, Japanese/English OS compatible, multi-mode fiber optic cable, dual loop, controller network (control/normal station), with external power supply function	
MELSECNET/H (10)	Optical loop (SI)	Q81BD-J71LP21-25	PCI Express bus, Japanese/English OS compatible, SI/QSI/H-PCF/broadband H-PCF fiber optic cable, dual loop, controller network (control/normal station)
		Q80BD-J71LP21-25	PCI bus, Japanese/English OS compatible, SI/QSI/H-PCF/broadband H-PCF fiber optic cable, dual loop, controller network (control/normal station)
		Q80BD-J71LP21S-25	PCI bus, Japanese/English OS compatible, SI/QSI/H-PCF/broadband H-PCF fiber optic cable, dual loop, controller network (control/normal station), with external power supply function
	Optical loop (GI)	Q80BD-J71LP21G	PCI bus, Japanese/English OS compatible, GI-50/125 fiber optic cable, dual loop, controller network (control/normal station)
		Q80BD-J71LP21GE	PCI bus, Japanese/English OS compatible, GI-62.5/125 fiber optic cable, dual loop, controller network (control/normal station)
	Coaxial bus	Q80BD-J71BR11	PCI bus, Japanese/English OS compatible, 3C-2V/5C-2V coaxial cable, single bus, controller network (control/normal station)
CC-Link	Q81BD-J61BT11	PCI Express bus, Japanese/English OS compatible, master/local interface board, CC-Link Ver. 2 compatible	
	Q80BD-J61BT11N	PCI bus, Japanese/English OS compatible, master/local interface board, CC-Link Ver. 2 compatible	

- Note 1) "Positive common" means using the module by connecting the common terminal to positive DC power; "negative common" means using the module by connecting the common terminal to negative DC power.
 Note 2) The connector is not enclosed. Prepare A6CON1, A6CON2, A6CON3, or A6CON4 separately.
 Note 3) The connector is not enclosed. Prepare A6CON1E, A6CON2E, or A6CON3E separately.
 Note 4) The connector is not enclosed. Prepare A6CON1, A6CON2, or A6CON4 separately.
 Note 5) The connector is not enclosed. Prepare A6CON4 separately.
 Note 6) Runs in Windows® command prompt.
 Note 7) Depending on the combination of the power supply module and base unit, the mounting position (slot) of Q68TD-G-H01 is restricted.
 Note 8) If the shipping standard compliance is required, select the Q64P model.

MELSOFT GX Series

Product	Model	Outline
GX Developer	SW□D5C-GPPW-E	MELSEC programmable controller programming software
	SW□D5C-GPPW-EV	MELSEC programmable controller programming software (upgrade)
GX Simulator	SW□D5C-LLT-E	MELSEC programmable controller simulation software
	SW□D5C-LLT-EV	MELSEC programmable controller simulation software (upgrade)
GX Configurator-AD	SW□D5C-QADU-E	MELSEC-Q dedicated analog to digital conversion module setting/monitoring tool
GX Configurator-DA	SW□D5C-QDAU-E	MELSEC-Q dedicated digital to analog conversion module setting/monitoring tool
GX Configurator-SC	SW□D5C-QSCU-E	MELSEC-Q dedicated serial communication module setting/monitoring tool
GX Configurator-CT	SW□D5C-QCTU-E	MELSEC-Q dedicated high-speed counter module setting/monitoring tool
GX Configurator-TC	SW□D5C-QTCU-E	MELSEC-Q dedicated temperature control module setting/monitoring tool
GX Configurator-TI	SW□D5C-QTIU-E	MELSEC-Q dedicated temperature input module setting/monitoring tool
GX Configurator-FL	SW□D5C-QFLU-E	MELSEC-Q dedicated FL-net module setting/monitoring tool
GX Configurator-PT	SW□D5C-QPTU-E	MELSEC-Q dedicated positioning module QD70 setting/monitoring tool
GX Configurator-AS	SW□D5C-QASU-E	MELSEC-Q dedicated AS-i master module setting/monitoring tool
GX Configurator-QP	SW□D5C-QD75P-E	MELSEC-Q dedicated positioning module QD75P/D/M setting/monitoring tool

MELSOFT MX Series

MX Component	SW□D5C-ACT-E	ActiveX library for communication
MX Sheet	SW□D5C-SHEET-E	Excel communication support tool
MX MESInterface	SW1DNC-MESIF-E	MES interface module QJ71MES96 dedicated information linkage tool
MX Works	SW□D5C-SHEETSET-E	A set of two products: MX Component, MX Sheet

Mitsubishi Programmable Controllers

Precautions for Choosing the Products

This publication explains the typical features and functions of the Q Series programmable controllers and does not provide restrictions and other information on usage and module combinations. When using the products, always read the user's manuals of the products.

Mitsubishi will not be held liable for damage caused by factors found not to be the cause of Mitsubishi; opportunity loss or lost profits caused by faults in the Mitsubishi products; damage, secondary damage, accident compensation caused by special factors unpredictable by Mitsubishi; damages to products other than Mitsubishi products; and to other duties.

For safe use

- To use the products given in this publication properly, always read the "manuals" before starting to use them.
- The products have been manufactured as general-purpose parts for general industries, and have not been designed or manufactured to be incorporated in a device or system used in purposes related to human life.
- Before using the products for special purposes such as nuclear power, electric power, aerospace, medicine or passenger movement vehicles, consult with Mitsubishi.
- The products have been manufactured under strict quality control. However, when installing the products where major accidents or losses could occur if the products fail, install appropriate backup or failsafe functions in the system.

Country/Region	Sales office	Tel/Fax
USA	Mitsubishi Electric Automation Inc. 500 Corporate Woods Parkway, Vernon Hills, IL 60061, USA	Tel: +1-847-478-2100 Fax: +1-847-478-0327
Brazil	MELCO-TEC Rep. Com.e Assessoria Tecnica Ltda. Av Paulista, 1439-Cj. 72 Cerqueira Cesar CEP 01311-200, Sao Paulo, SP, CEP: 01311-200, Brazil	Tel: +55-11-3146-2200 Fax: +55-11-3146-2217
Germany	Mitsubishi Electric Europe B.V. German Branch Gothaer Strasse 8, D-40880 Ratingen, Germany	Tel: +49-2102-486-0 Fax: +49-2102-486-1120
UK	Mitsubishi Electric Europe B.V. UK Branch Travellers Lane, Hatfield, Hertfordshire, AL10 8XB, UK	Tel: +44-1707-276100 Fax: +44-1707-278992
Italy	Mitsubishi Electric Europe B.V. Italy Branch Viale Colleoni 7-20041 Agrate Brianza (Milano), Italy	Tel: +39-039-60531 Fax: +39-039-6053312
Spain	Mitsubishi Electric Europe B.V. Spanish Branch Carretera de Rubi 76-80 E-08190 Sant Cugat del Valles (Barcelona), Spain	Tel: +34-93-565-3131 Fax: +34-93-589-1579
France	Mitsubishi Electric Europe B.V. French Branch 25, Boulevard des Bouvets, F-92741 Nanterre Cedex, France	Tel: +33-1-5568-5568 Fax: +33-1-5568-5757
South Africa	Circuit Breaker Industries Ltd. Private Bag 2016, ZA-1600 Isando, South Africa	Tel: +27-11-928-2000 Fax: +27-11-392-2354
Hong Kong	Mitsubishi Electric Automation (Hong Kong) Ltd. 10/F, Manulife Tower, 169 Electric Road, North Point, Hong Kong	Tel: +852-2887-8870 Fax: +852-2887-7984
China	Mitsubishi Electric Automation (Shanghai) Ltd. 17/F Chong Hing Finance Center, No.288 West Nanjing Road, Shanghai 200003, China	Tel: +86-21-2322-3030 Fax: +86-21-2322-3000
Taiwan	Setsuyo Enterprise Co., Ltd. 6F, No.105 Wu-Kung 3rd Rd, Wu-Ku Hsiang, Taipei Hsien 248, Taiwan	Tel: +886-2-2299-2499 Fax: +886-2-2299-2509
Korea	Mitsubishi Electric Automation Korea Co., Ltd. 1480-6, Gayang-dong, Gangseo-ku, Seoul 157-200, Korea	Tel: +82-2-3660-9552 Fax: +82-2-3664-8372
Singapore	Mitsubishi Electric Asia Pte, Ltd. 307 Alexandra Road #05-01/02, Mitsubishi Electric Building Singapore 159943	Tel: +65-6470-2460 Fax: +65-6476-7439
Thailand	Mitsubishi Electric Automation (Thailand) Co., Ltd. Bang-Chan Industrial Estate No.111 Soi Serithai 54, T.Kannayao, A.Kannayao, Bangkok 10230 Thailand	Tel: +66-2-517-1326 Fax: +66-2-517-3239
Indonesia	P.T. Autoteknindo Sumber Makmur Muara Karang Selatan Block A/Utara No.1 Kav. No.11, Kawasan Industri Pergudangan, Jakarta - Utara 14440, P.O. Box 5045 Jakarta 11050, Indonesia	Tel: +62-21-663-0833 Fax: +62-21-663-0832
India	Messung Systems Pvt., Ltd. Electronic Sadan NO: III Unit No.15, M.I.D.C. Bhosari, Pune-411026, India	Tel: +91-20-2712-3130 Fax: +91-20-2712-8108
Australia	Mitsubishi Electric Australia Pty. Ltd. 348 Victoria Road, Rydalmere, N.S.W. 2116, Australia	Tel: +61-2-9684-7777 Fax: +61-2-9684-7245



HEAD OFFICE: TOKYO BUILDING, 2-7-3, MARUNOUCHI, CHIYODA-KU, TOKYO 100-8310, JAPAN
NAGOYA WORKS: 1-14, YADA-MINAMI 5, HIGASHI-KU, NAGOYA, JAPAN